

APX™ TWO-WAY RADIOS

# APX 2000 MODEL 1 USER GUIDE







# ASTRO® APX™ 2000 Series Digital Portable Radios Quick Reference Card

## RF Energy Exposure and Product Safety Guide for Portable Two-Way Radios

### ATTENTION!

This radio is restricted to **Occupational use only**. Before using the radio, read the RF Energy Exposure and Product Safety Guide for Portable Two-Way Radios which contains important operating instructions for safe usage and RF energy awareness and control for Compliance with applicable standards and Regulations.

### Radio Controls

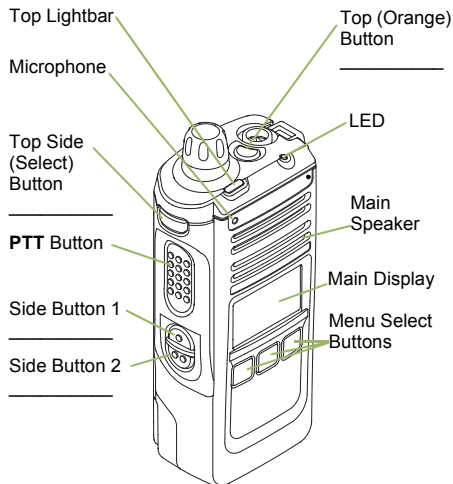
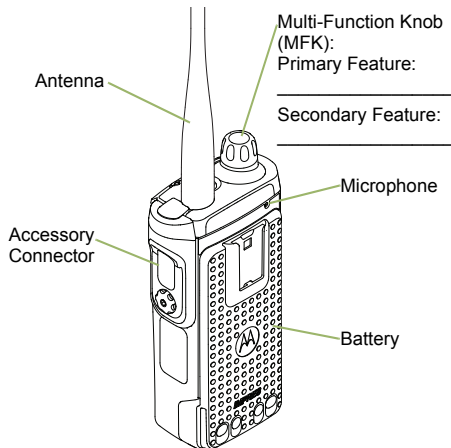

### Radio On/Off

- **On** – Press and hold the **MFK** until the display lights up.
- **Off** – Press and hold the **MFK** until you see **Power off?**, then press **Menu Select** button below **Yes**.

### Zones and Channels

- 1 Press the **MFK** to see  on the screen.
- 2 Turn the **MFK** to scroll to desired zone or channel.
- 3 Press **MFK** to select the desired zone or channel and exit Mode Change.

### Receiving and Transmitting

- 1 Select zone/channel.
- 2 Listen for a transmission.  
**OR**  
Press and hold **Volume Set** button.  
**OR**  
Press **Monitor** button and listen for activity.
- 3 Adjust volume, if necessary.
- 4 Press the **PTT** button to transmit; release to receive.

### Sending an Emergency Alarm

- 1 Press and hold the **Emergency** button\*.
- 2 The display shows **Emergency** and the current zone/channel. Radio sounds a short, medium-pitched tone, and the LED blinks red momentarily.
- 3 When acknowledgment is received, you hear four beeps; alarm ends; and radio exits emergency.

*\*Default timer of Emergency button press to activate Emergency is 50 milliseconds. This timer is programmable, see Emergency Operation in the user guide for details.*

*To exit emergency at any time, press and hold the Emergency button.*



PMLN6231C



English

## ■ Sending an Emergency Call

- 1 Press the **Emergency** button.
- 2 Press and hold the **PTT** button. Speak clearly into the microphone.
- 3 Release the **PTT** button to end call.
- 4 Press and hold **Emergency** button to exit emergency.











*To exit emergency at any time, press and hold the **Emergency** button.*





## ■ Sending a Silent Emergency Call

- 1 Press the **Emergency** button.
- 2 The display does not change; the LED does not light up, and there is no tone.
- 3 Silent emergency continues until you:  
Press and hold the **Emergency** button to exit emergency state.  
**OR**  
Press and release the **PTT** button to exit the Silent Emergency Alarm mode and enter regular dispatch or Emergency Call mode.

*To exit emergency at any time, press and hold the **Emergency** button.*

## ■ Display Status Icons

	Receiving a call or data
	Transmitting a call or data
	Blinks when the battery is low.
	The more stripes, the stronger the signal strength for the current site (trunking only).
	Direct radio to radio communication or connected through a repeater. <b>On</b> = Direct <b>Off</b> = Repeater
	This channel is being monitored.
	<b>L</b> = Radio is set at Low power. <b>H</b> = Radio is set at High power.
	Scanning a scan list.
	<b>Blinking dot</b> = Detects activity on the Priority-One Channel during scan. <b>Steady dot</b> = Detects activity on the Priority-Two Channel during scan.
	The vote scan feature is enabled.

	<b>On</b> = User is currently associated with the radio. <b>Off</b> = User is currently not associated with the radio. <b>Blinking</b> = Device registration or user registration with the server failed due to an invalid username or pin.
	Data activity is present.
	<b>MFK</b> is in Mode Change feature.
	<b>MFK</b> is in Volume Change feature.
	<b>On</b> = Secure operation. <b>Off</b> = Clear operation. <b>Blinking</b> = Receiving an encrypted voice call.

# Contents

**Declaration of Conformity..... 6**

**Important Safety Information..... 8**

**Software Version..... 9**

Notice to Users (FCC and Industry  
Canada)..... 9

**Consignes de sécurité  
importantes..... 10**

**Version logicielle..... 11**

Avis aux utilisateurs (FCC et Industrie  
Canada)..... 11

**Computer Software Copyrights.... 12**

**Documentation Copyrights..... 13**

**Disclaimer..... 14**

**Getting Started..... 15**

How to Use This Guide..... 15

Notations Used in This Manual..... 15

Additional Performance Enhancement..... 15

Dynamic System Resilience (DSR).... 15

CrossTalk Prevention..... 15

Conventional Talkgroup and Radio

Scan Enhancements..... 16

What Your Dealer/System Administrator

Can Tell You..... 16

**Preparing Your Radio for Use..... 18**

Charging the Battery..... 18

Attaching the Battery..... 18

Attaching the Antenna..... 19

Removing and Attaching the Accessory

Connector Cover..... 20

Attaching the Belt Clip.....	21
Turning On the Radio.....	21
Adjusting the Volume.....	22

## Identifying Radio Controls..... 24

Radio Parts and Controls.....	24
Programmable Features.....	25
Assignable Radio Functions.....	25
Assignable Settings or Utility Functions.....	27
Accessing the Preprogrammed Functions.....	27
Menu Select Buttons.....	28
Multi-Function Knob (MFK).....	28
Push-To-Talk (PTT) Button.....	29

## Identifying Status Indicators..... 30

Status Icons.....	30
LED Indicator.....	32
Top Lightbar Indicator.....	33
Intelligent Lighting Indicators.....	34
Alert Tones.....	35
Phone Call Displays and Alerts.....	38

## General Radio Operation..... 39

Selecting a Zone.....	39
Selecting a Radio Channel.....	39
Mode Select Feature.....	40
Saving a Zone and a Channel to a Softkey.....	40
Saving a Zone and a Channel to a Button.....	40
Receiving and Responding to a Radio Call... 41	
Receiving and Responding to a Talkgroup Call.....	41
Receiving and Responding to a Private Call (Trunking Only).....	41
Receiving and Responding to a Telephone Call (Trunking Only)....	42
Switching Between Repeater or Direct Operation Button.....	43
Monitor Feature.....	43
Monitoring a Channel.....	43
Monitoring Conventional Mode.....	44

## Advanced Features..... 45

Advanced Call Features.....	45
-----------------------------	----

Selective Call (ASTRO Conventional Only).....	45	Fireground (Conventional Only).....	53
Responding to the Dynamic Regrouping Feature (Trunking Only).....	45	Entering Fireground Zone Channel.....	54
Scan Lists.....	46	Responding to Evacuation Indicator... ..	54
Viewing a Scan List.....	47	Automatic Registration Service (ARS).....	55
Viewing and Changing the Priority Status.....	47	Selecting or Changing the ARS Mode.....	55
Scan.....	47	Secure Operations.....	56
Turning Scan On or Off.....	47	Selecting Secure Transmissions.....	56
Making a Dynamic Priority Change (Conventional Scan Only).....	48	Selecting Clear Transmissions.....	57
Deleting a Nuisance Channel.....	48	Managing Encryption.....	57
Restoring a Nuisance Channel.....	49	Trunking System Controls.....	59
Call Alert Paging.....	49	Operating in Failsafe System.....	59
Receiving a Call Alert Page.....	49	Out-of-Range Radio.....	60
Emergency Operation.....	49	Site Trunking Feature.....	60
Sending an Emergency Alarm.....	50	Locking and Unlocking a Site.....	60
Sending an Emergency Call (Trunking Only).....	51	Site Display and Search Button.....	61
Sending an Emergency Alarm with Emergency Call.....	51	Over-the-Air Programming (POP 25, ASTRO 25, ASTRO Conventional).....	61
Sending a Silent Emergency Alarm....	52	Responding to the Notification of Upgrade.....	62
Change of Channels during Emergency.....	52	Voice Announcement.....	63
Emergency Keep-Alive Feature.....	53	Site Selectable Alerts (ASTRO 25).....	64
		Utilities.....	64
		Selecting the Power Level.....	64
		Enabling and Disabling the Radio Alias.....	65
		Controlling the Display Backlight.....	65

Locking and Unlocking the Controls...	66
Turning the Controls and Buttons	
Tones On or Off.....	66
Turning Voice Mute On or Off.....	66
Using the Time-Out Timer.....	67
Using Conventional Squelch	
Operation Features.....	67
Using the PL Defeat Feature.....	68
Digital PTT ID Support.....	68
Smart PTT Feature (Conventional	
Only).....	68
Viewing the IP Address.....	69
Transmit Inhibit.....	69

## **Helpful Tips..... 71**

Radio Care.....	71
Cleaning Your Radio.....	71
Proper Ways to Handle the Radio.....	72
Radio Service and Repair.....	72
Battery Care.....	72
Battery Charge Status.....	72
Battery Recycling and Disposal.....	73

## **Accessories.....74**

## **Maritime Radio Use in the VHF**

### **Frequency Range..... 75**

Special Channel Assignments.....	75
Emergency Channel.....	75
Non-Commercial Call Channel.....	75
Operating Frequency Requirements.....	75
Declaration of Compliance for the Use of	
Distress and Safety Frequencies.....	78
Technical Parameters for Interfacing	
External Data Sources.....	78

## **Glossary.....79**

### **Limited Warranty.....84**

MOTOROLA COMMUNICATION	
PRODUCTS.....	84
I. WHAT THIS WARRANTY COVERS	
AND FOR HOW LONG:.....	84
II. GENERAL PROVISIONS:.....	85
III. STATE LAW RIGHTS:.....	86
IV. HOW TO GET WARRANTY SERVICE:...	86



V. WHAT THIS WARRANTY DOES NOT COVER:.....	86
VI. PATENT AND SOFTWARE PROVISIONS:.....	87
VII. GOVERNING LAW:.....	88
VIII. For Australia Only.....	88

## Declaration of Conformity

This declaration is applicable to your radio only if your radio is labeled with the FCC logo shown below.

### Declaration of Conformity

Per FCC CFR 47 Part 2 Section 2.1077(a)



Responsible Party

Name: Motorola Solutions, Inc.

Address: 1303 East Algonquin Road, Schaumburg, IL 60196-1078, U.S.A.

Phone Number: 1-800-927-2744

Hereby declares that the product:

Model Name: **APX 2000**

conforms to the following regulations:

FCC Part 15, subpart B, section 15.107(a), 15.107(d) and section 15.109(a)

## Class B Digital Device

As a personal computer peripheral, this device complies with Part 15 of the FCC Rules. Operation is subject to the following two conditions:

- 1 This device may not cause harmful interference, and
- 2 This device must accept any interference received, including interference that may cause undesired operation.



### Note:

This equipment has been tested and found to comply with the limits for a Class B digital device, pursuant to part 15 of the FCC Rules. These limits are designed to provide reasonable protection against harmful interference in a residential installation. This equipment generates, uses and can radiate radio frequency energy and, if not installed and used in accordance with the instructions, may cause harmful interference to radio communications. However, there is no guarantee that interference will not occur in a particular installation.

If this equipment does cause harmful interference to radio or television reception, which can be determined by turning the equipment off and on, the user is encouraged to try to correct the interference by one or more of the following measures:

- Reorient or relocate the receiving antenna.
- Increase the separation between the equipment and receiver.
- Connect the equipment into an outlet on a circuit different from that to which the receiver is connected.
- Consult the dealer or an experienced radio or TV technician for help.

## Important Safety Information

### RF Energy Exposure and Product Safety Guide for Portable Two-Way Radios

#### ATTENTION!

#### **This radio is restricted to Occupational use only.**

Before using the radio, read the RF Energy Exposure and Product Safety Guide for Portable Two-Way Radios which contains important operating instructions for safe usage and RF energy awareness and control for Compliance with applicable standards and Regulations.

For a list of Motorola-approved antennas, batteries, and other accessories, visit the following website:

<http://www.motorolasolutions.com/APX>

*Under Industry Canada regulations, this radio transmitter may only operate using an antenna of a type and maximum (or lesser) gain approved for the transmitter by Industry Canada. To reduce potential radio interference to other users, the antenna type and its gain should be so chosen that the equivalent isotropically radiated power (e.i.r.p.) is not more than that necessary for successful communication.*

*This radio transmitter has been approved by Industry Canada to operate with Motorola-approved antenna with the maximum permissible gain and required antenna impedance for each antenna type indicated. Antenna types not included in this list, having a gain greater than the maximum gain indicated for that type, are strictly prohibited for use with this device.*

## Software Version

All the features described in the following sections are supported by the software version **R14.00.00** or later.

See [Accessing the Radio Information](#) to determine the software version of your radio.

Check with your dealer or system administrator for more details of all the features supported.

### Notice to Users (FCC and Industry Canada)

This device complies with Part 15 of the FCC rules and RSS 210 of the Industry Canada rules per the following conditions:

- This device may not cause harmful interference.
- This device must accept any interference received, including interference that may cause undesired operation.
- Changes or modifications made to this device, not expressly approved by Motorola, could void the authority of the user to operate this equipment.

## Consignes de sécurité importantes

### Radios bidirectionnelles portatives : exposition aux radiofréquences et sécurité du produit

#### ATTENTION!

**Cette radio ne doit être utilisée qu'à des fins professionnelles.** Avant d'utiliser la radio, lisez le guide Radios bidirectionnelles portatives : exposition aux radiofréquences et sécurité du produit, qui contient d'importantes instructions de fonctionnement pour une utilisation sécuritaire et des informations sur l'exposition aux fréquences radioélectriques, dans le but d'assurer votre conformité aux normes et règlements en vigueur.

Visitez le site Web suivant pour obtenir la liste des antennes, des batteries et des autres accessoires approuvés par Motorola :

<http://www.motorolasolutions.com/APX>

*Selon la réglementation d'Industrie Canada, cet émetteur radio ne peut être utilisé qu'avec une antenne dont le type et le gain maximal (ou minimal) sont approuvés par Industrie Canada pour cet émetteur. Afin de limiter les interférences radio pour*

*les autres utilisateurs, le type et le gain de l'antenne doivent être choisis de façon à ce que la puissance isotrope rayonnée équivalente (P.I.R.E.) ne soit pas plus forte qu'il ne le faut pour établir la communication.*

*Cet émetteur radio a été approuvé par Industrie Canada pour utilisation avec une antenne approuvée par Motorola offrant le gain maximal autorisé et l'impédance requise pour le type d'antenne indiqué. Il est strictement interdit d'utiliser avec cet appareil tout type d'antenne ne figurant pas dans cette liste et présentant un gain supérieur au maximum indiqué pour le type.*

## Version logicielle

Toutes les fonctions décrites dans les sections suivantes sont prises en charge par la version **R14.00.00** ou les versions ultérieures du logiciel de la radio.

Pour obtenir davantage de renseignements à propos des fonctions prises en charge, adressez-vous à votre détaillant ou à votre administrateur de système.

### **Avis aux utilisateurs (FCC et Industrie Canada)**

---

Cet appareil est conforme à la Partie 15 des règlements de la FCC et RSS 210 du règlement d'Industrie Canada selon les conditions énumérées ci-dessous:

- Ce dispositif ne doit pas causer d'interférences nuisibles.
- Cet appareil doit accepter toute interférence reçue, y compris les interférences qui peuvent perturber le fonctionnement.
- Les changements ou les modifications apportées à ce dispositif, non expressément approuvées par

Motorola, peuvent annuler le droit de l'utilisateur à utiliser cet équipement.

---

## Computer Software Copyrights

The Motorola products described in this manual may include copyrighted Motorola computer programs stored in semiconductor memories or other media. Laws in the United States and other countries preserve for Motorola certain exclusive rights for copyrighted computer programs including, but not limited to, the exclusive right to copy or reproduce in any form the copyrighted computer program. Accordingly, any copyrighted Motorola computer programs contained in the Motorola products described in this manual may not be copied, reproduced, modified, reverse-engineered, or distributed in any manner without the express written permission of Motorola. Furthermore, the purchase of Motorola products shall not be deemed to grant either directly or by implication, estoppel, or otherwise, any license under the copyrights, patents or patent applications of Motorola, except for the normal non-exclusive license to use that arises by operation of law in the sale of a product.





## Documentation Copyrights

No duplication or distribution of this document or any portion thereof shall take place without the express written permission of Motorola. No part of this manual may be reproduced, distributed, or transmitted in any form or by any means, electronic or mechanical, for any purpose without the express written permission of Motorola.

---

## Disclaimer

The information in this document is carefully examined, and is believed to be entirely reliable. However, no responsibility is assumed for inaccuracies. Furthermore, Motorola reserves the right to make changes to any products herein to improve readability, function, or design. Motorola does not assume any liability arising out of the applications or use of any product or circuit described herein; nor does it cover any license under its patent rights, nor the rights of others.

---

## Getting Started

### How to Use This Guide

---

This User Guide covers the basic operation of the APX Portables.

However, your dealer or system administrator may have customized your radio for your specific needs. Check with your dealer or system administrator for more information.

### Notations Used in This Manual

---

Throughout the text in this publication, you will notice the use of **Warning**, **Caution**, and **Note**. These notations are used to emphasize that safety hazards exist, and the care that must be taken or observed.

**Warning:**

An operational procedure, practice, or condition and so on, which may result in injury or death if not carefully observed.

**Caution:**

An operational procedure, practice, or condition and so on, which may result in

damage to the equipment if not carefully observed.

**Note:**

An operational procedure, practice, or condition and so on, which is essential to emphasize.

### Additional Performance Enhancement

---

The following performance enhancements are some of the latest creations designed to enhance the security, quality and efficiency of the radios.

#### Dynamic System Resilience (DSR)

DSR ensures the radio system is seamlessly switched to a backup master site dynamically in case of system failure. DSR also provides additional indication e.g. failure detection, fault recovery, and redundancy within the system to address to the user in need. Mechanisms related to the Integrated Voice and Data (IV&D) or data centric are all supported by DSR.

#### CrossTalk Prevention

This feature prevents crosstalk scenarios from happening, especially when a wideband antenna is

used. This feature allows the adjustment of the internal SSI clock rate of the radio. This subsequently reduces the possibility of radio frequency interfering spurs and prevents the issues of crosstalk.

## Conventional Talkgroup and Radio Scan Enhancements

A few enhancements have been made to the Conventional Talkgroup at the system. These enhancements improve the Scan feature operation significantly when multiple agencies are using a single conventional radio frequency channel. These enhancements allow users to use Selective Squelch to operate on only the subset of talkgroups that are relevant to the users rather than all talkgroups on the channel. These Scan improvements have been made to eliminate the audio holes that were present and to turn on the busy LED when activity is present on the channel. Mixed Vote Scan and Standard Conventional Scan configurations are supported. Priority Operation is also supported.

Up to 30 different talkgroups can be supported using conventional channels. A maximum of four talkgroups can be supported when Vote Scan channels are being used.

Smart **PTT** is supported with this enhancement as Smart **PTT** prevents users from transmitting while other users are on the channel.



### Note:

User Selectable Talkgroups are not compatible with this Conventional Talkgroup Enhancement.

## What Your Dealer/System Administrator Can Tell You

---

Check with your dealer or system administrator for the correct radio settings, if the radio is to be operated in extreme temperatures (less than -30 °C or more than +60 °C).

You can consult your dealer or system administrator about the following:

- Is your radio programmed with any preset conventional channels?
- Which buttons have been programmed to access other features?
- What optional accessories may suit your needs?



**Note:**

Specifications may vary for different radio models. Check with your dealer or system administrator for more information.

## Preparing Your Radio for Use

This section provides simple instructions to prepare your radio for use.

### Charging the Battery

**Warning:**

To avoid a possible explosion:

- Do **not** replace the battery in any area labeled **hazardous atmosphere**.
- Do **not** discard batteries in a fire.

The Motorola-approved battery shipped with your radio is uncharged. Prior to using a new battery, charge it for a minimum of 16 hours to ensure optimum capacity and performance. For a list of Motorola-authorized batteries and chargers available for use with your radio, see [Accessories](#) on page 74.

**Note:**

When charging a battery attached to a radio, turn the radio off to ensure a full charge.

To charge the battery, place the battery (with or without the radio) in a Motorola-approved charger.

The LED on the charger indicates the charging progress; see the charger user guide.

### Attaching the Battery

- 1 Slide the battery into the radio frame until the latch which is at the bottom of the radio clicks into place.

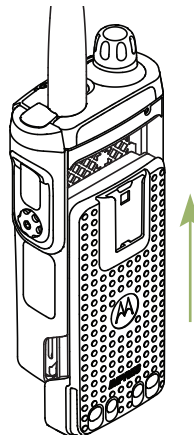

- 2 To remove the battery, lift up the latch **A** which is at the bottom of the radio, then slide the battery out from the radio.

**Note:**

When removing the battery, ensure that the radio is turned off.

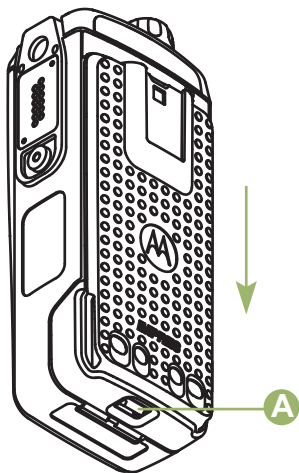

## Attaching the Antenna

---

Ensure the radio is turned off before attaching the antenna.

- 1 Set the antenna in its receptacle.
- 
- 2 Turn the antenna clockwise to attach to the radio.

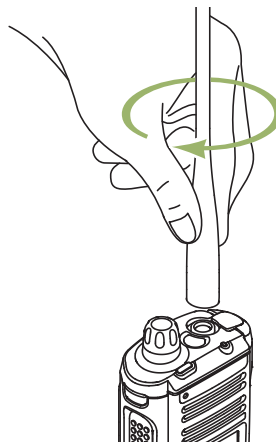

- 3 To remove the antenna, turn the antenna counterclockwise.



**Note:**

When removing the antenna, ensure that the radio is turned off.

---

## Removing and Attaching the Accessory Connector Cover

---

The accessory connector is on the antenna side of the radio. It is used to connect accessories to the radio.



**Note:**

To prevent damage to the connector, shield it with the connector cover when not in use.

- 1 To remove the accessory connector cover, rotate the thumbscrew **B** counterclockwise until it disengages from the radio.



**Note:**

If the thumbscrew is too tight, use an Allen wrench at **C** to loosen it first.

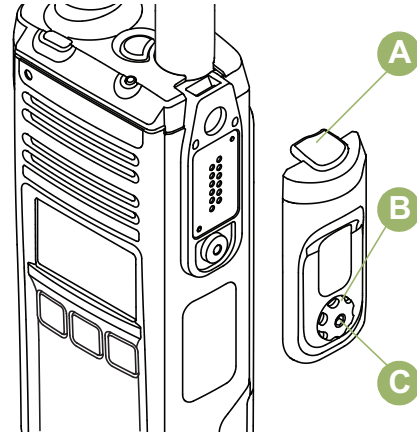

- 2 Rotate and lift the connector cover to disengage it from the radio.
- 3 To attach the accessory connector cover, insert the hooked end **A** of the cover into the slot above the connector.
- 4 Press downward on the cover's top to seat it in the slot.
- 5 Once in place, tighten by rotating the thumbscrew **B** clockwise by hand.



## Attaching the Belt Clip

---

- 1 Align the grooves of the belt clip with those of the radio and push down until you hear a click.

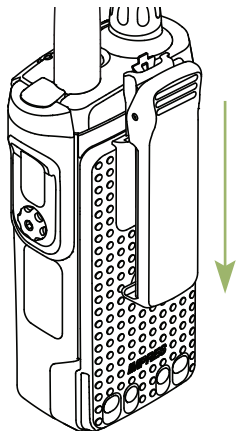

- 2 To remove the clip, use a flatbladed object to press the belt clip tab **A** away from the radio. Then, slide the clip upward and away from the radio.

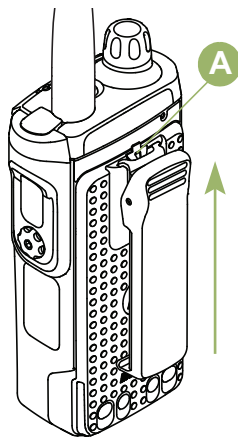

---

## Turning On the Radio

---

- 1 Press the **Multi-Function Knob** until the radio display lights on, then release the knob.

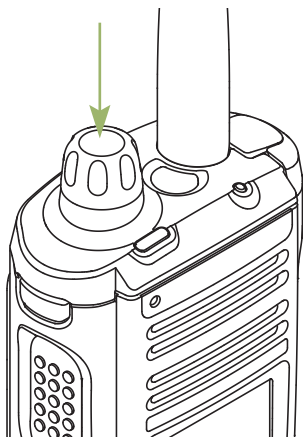

- If the power-up test is successful, you see momentary **SELFTEST** on the radio display, followed by the Home screen.
- If the power-up test is unsuccessful, you see **Error XX/YY** (XX/YY is an alphanumeric code).

**Note:**

If the radio fails to power-up after repeating a few times, record the **Error XX/YY** code and contact your dealer.

- 2 To turn off the radio, press and hold the **Multi-Function Knob** until the radio display shows **Power off?**, press the **Menu Select** button below **Yes** to power off.

---

## Adjusting the Volume

---

Ensure the radio is power on and the main speaker is pointed towards you for increased loudness and intelligibility, especially in areas with loud background noises.

Your radio is preprogrammed to reset to medium volume rate, which is Level 12, by default whenever the radio powers up.

- 1 To increase the volume, rotate the **Multi-Function Knob** Ⓐ clockwise.

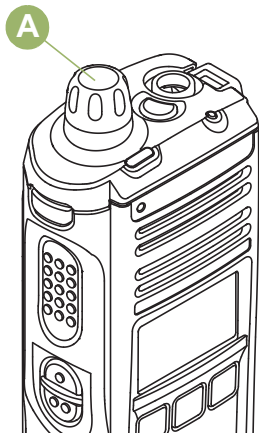

- 
- 2** To decrease the volume, rotate this knob counterclockwise.
- 

The display shows volume bars and volume level when you change the volume.

# Identifying Radio Controls

## Radio Parts and Controls

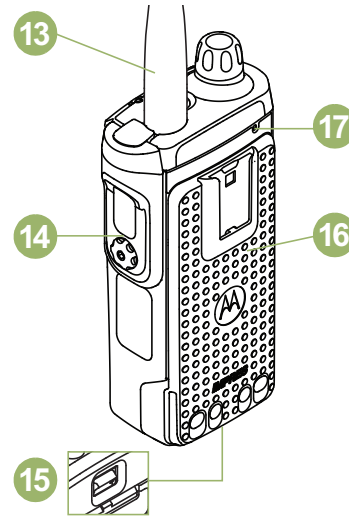
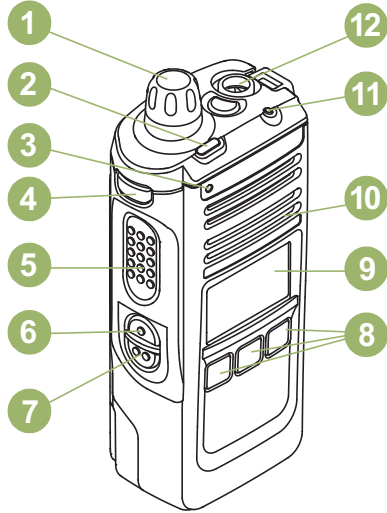

1	Multi-Function Knob (MFK) <sup>[1]</sup>
2	Top Lightbar
3	Microphone
4	Top Side (Select) Button <sup>[1]</sup>
5	Push-to-Talk (PTT) Button
6	Side Button 1 <sup>[1]</sup>

7	Side Button 2 <sup>[1]</sup>
8	Menu Select Buttons
9	Main Display
10	Speaker
11	LED
12	Top (Orange) Button <sup>[1]</sup>
13	Antenna
14	Accessory Connector
15	Battery Latch (at the bottom)
16	Battery
17	Microphone

## Programmable Features

Any reference in this manual to controls that are preprogrammed means that a qualified radio

<sup>1</sup> These radio controls/buttons are programmable.

technician must use the radio programming software to assign a feature to a control.

Your dealer can program the programmable buttons as shortcuts to radio functions or preset channels/groups depending on the duration of a button press:

**Press** Pressing and releasing rapidly.

**Long press** Pressing and holding for the preprogrammed duration (between 0.25 seconds and 3.75 seconds).

**Hold down** Keeping the button pressed.

## Assignable Radio Functions

**Call Response** Allows you to answer a private call.

**Dynamic Priority (Conventional Only)** Allows any channel in a Scan List (except for the Priority-One channel) to temporarily replace the Priority-Two channel.

**Emergency** Depending on the programming, initiates or

	cancels an emergency alarm or call.		separately programmed buttons for four different features.
<b>Internet Protocol Address</b>	Display the Internet Protocol (IP) address, device name and status of the radio.	<b>Private Line Defeat (Conventional Only)</b>	Overrides any coded squelch (DPL or PL) that is preprogrammed to a channel.
<b>Mode Select</b>	Long-press programs a button with the current zone and channel of the radio; once programmed, the short-press of that button changes the radio zone channel to the programmed zone and channel.	<b>Repeater Access Button (RAB) (Conventional Only)</b>	Allows user to manually send a repeater access codeword.
<b>Monitor (Conventional Only)</b>	Monitors a selected channel for all radio traffic until function is disabled.	<b>Reprogram Request (Trunking Only)</b>	Notifies the dispatcher you want a new dynamic regrouping assignment.
<b>Nuisance Delete</b>	Temporarily removes an unwanted channel, except for priority channels or the designated transmit channel from the scan list.	<b>Request-To-Talk (Conventional Only)</b>	Notifies the dispatcher you want to send a voice call.
<b>One Touch 1– 4</b>	Launches a specific feature with one single button-press. You can setup as many as four	<b>Scan</b>	Toggles scan on or off.
		<b>Scan List Programming</b>	Selects the scan list for editing (by long press on the Scan button).
		<b>Secure Transmission Select</b>	Toggles the Secure Transmission On or Off when the Secure/Clear Strapping

<b>(Conventional and Trunking)</b>	fields is set to <code>Select</code> for the current channel and when the radio is model/option capable.
<b>Site Display/Search (Trunking Only)</b>	Displays the current site ID and RSSI value; performs site search for Automatic Multiple Site Select (AMSS) or SmartZone operation.
<b>Site Lock/Unlock (Trunking Only)</b>	Locks onto a specific site.
<b>Talkaround/Direct (Conventional Only)</b>	Toggles between using a repeater and communicating directly with another radio.

### Assignable Settings or Utility Functions

<b>Keypad/Controls Lock</b>	Locks or unlocks the keypad, programmable buttons, switches or rotary knobs.
<b>Light/Flip</b>	Press the button to toggle the display backlight on or off; press and hold the button to reverse the content of the top display.

<b>Voice Announcement</b>	Audibly indicates the current feature mode, Zone or Channel the user has just assigned.
<b>Voice Mute</b>	Toggles voice mute on or off.
<b>Volume Set Tone</b>	Sets the volume set tone.

## Accessing the Preprogrammed Functions

You can access various radio functions through one of the following methods.

- A short or long press of the relevant programmable buttons.
- Use the **Menu Select** buttons below the softkeys.

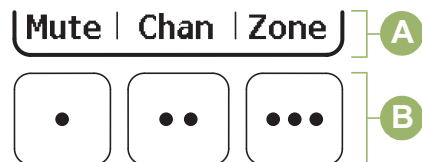

A	Softkeys
B	Menu Select Buttons

## Menu Select Buttons



### Note:

Check with your dealer or system administrator for the list of features activated in your radio.

Use the **Menu Select** button to access the menu entry of your radio feature. Your radio may be preprogrammed differently from the following example, but the steps for selecting a channel may appear as shown below:

Press the **Menu Select** button directly below Chan.

## Multi-Function Knob (MFK)

**MFK** is the on/off button of your radio. See [Turning On the Radio](#) on page 21 for the procedure to power up and down the radio.

In addition, there are programmable features available for **MFK**. The two programmable features are as the following.

### Mode Change

Turn **MFK** to scroll the channel or zone list.



## Volume Change



Turn **MFK** to increase or decrease the volume level of the speaker. Fast turn of **MFK** makes coarse tuning of the volume level; slow turn of **MFK** makes fine tuning of the volume level. The display shows the volume level and bars to indicate the current level. The level of last selected volume before the radio powers down remains the same when the radio powers up.

The radio by default is set to use the primary feature. Short presses of **MFK** toggle it to work on either the secondary or primary feature.

The main display only shows the icon of secondary feature; the main display does not show the icon of primary feature.

The secondary feature has an inactivity timer. This timer starts when the secondary feature is left idle. Your radio returns to primary feature when this timer expires.

If the **MFK** is set to operate only one feature besides On/Off the radio, Volume Change should be the only feature applied to **MFK**.



Consult your dealer or system administrator for the best options available for **MFK**.

Press and hold down **PTT** button to talk. Release the **PTT** button to listen. The microphone is activated when the **PTT** button is pressed.

## Push-To-Talk (PTT) Button

---

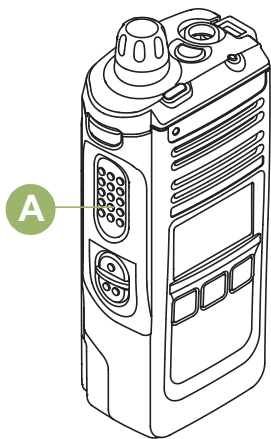



The **PTT** button **A** on the side of the radio serves two basic purposes:





- While a call is in progress, the **PTT** button allows the radio to transmit to other radios in the call.



## Identifying Status Indicators





### Status Icons



The 160 x 90 pixel front liquid crystal display (LCD) of your radio shows radio status, text entries, and menu entries. The top two display rows contain color icons that indicate radio operating conditions.

	<p><b>Receiving</b> Radio is receiving a call or data.</p>
	<p><b>Transmitting</b> Radio is transmitting a call or data.</p>
	<p><b>Battery</b> For IMPRES™ battery operation only – the icon shown indicates the charge remaining in the battery.  For all battery operation – the icon blinks when the battery is low.</p>

	<p><b>Received Signal Strength Indicator (RSSI)</b>  The number of bars displayed represents the received signal strength for the current site, for trunking only. The more stripes in the icon, the stronger the signal.</p>
	<p><b>Roaming</b>  The radio has roamed to and is currently registered to a foreign system.</p>
	<p><b>Direct</b>  <b>On</b> – Radio is currently configured for direct radio-to-radio communication (during conventional operation only).  <b>Off</b> – Radio is connected with other radios through a repeater.</p>
	<p><b>Monitor (Carrier Squelch)</b>  Selected channel is being monitored (during conventional operation only).</p>

	<p><b>In-Call User Alert</b></p> <p><b>On</b> – The feature is enabled. Voice muting of the affiliated trunking talkgroup or selected conventional channel is activated.</p> <p><b>Off</b> – The feature is disabled. Voice muting of the affiliated trunking talkgroup or selected conventional channel is deactivated.</p>
<b>H</b> or <b>L</b>	<p><b>Power Level</b></p> <p><b>L</b> – Radio is set at Low power.</p> <p><b>H</b> – Radio is set at High power.</p>
	<p><b>Scan</b></p> <p>Radio is scanning a scan list.</p>
	<p><b>Priority Channel Scan</b></p> <p><b>Blinking dot</b> – Radio detects activity on channel designated as Priority-One.</p> <p><b>Steady dot</b> – Radio detects activity on channel designated as Priority-Two.</p>

	<p><b>Vote Scan Enabled</b></p> <p>The vote scan feature is enabled.</p>
	<p><b>Secure Operation</b></p> <p><b>On</b> – Secure operation.</p> <p><b>Off</b> – Clear operation.</p> <p><b>Blinking</b> – Receiving an encrypted voice call.</p>
	<p><b>GPS Signal</b></p> <p><b>On</b> – Feature is enabled and signal is available.</p> <p><b>Off</b> – Feature is disabled.</p> <p><b>Blinking</b> – Feature is enabled, but no signal is available.</p>
	<p><b>User Login Indicator (IP Packet Data)</b></p> <p><b>On</b> – User is currently associated with the radio.</p> <p><b>Off</b> – User is currently not associated with the radio.</p>

	<p><b>Blinking</b> – Device registration or user registration with the server failed due to an invalid username or pin.</p> <p><b>Inverted</b> – User successfully login to the secured IP Packet Data.</p>
	<p><b>Data Activity</b></p> <p>Data activity is present.</p>
	<p><b>MFK is in Mode Change feature</b></p> <p>Turn the MFK to change the channel/zone.</p>
	<p><b>MFK is in Volume Change feature</b></p> <p>Turn the MFK to turn the volume up or down.</p>

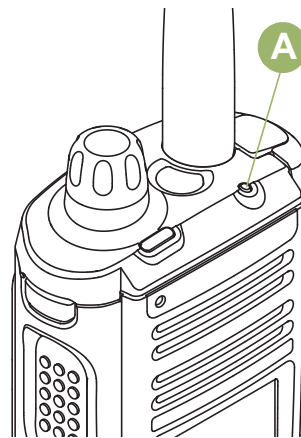

<b>Solid red</b>	Radio is transmitting.
<b>Blinking red</b>	Radio is transmitting at low battery condition.
<b>Double blinking red</b>	Radio is in Emergency Mode.
<b>Rapidly blinking red</b>	Radio has failed the self test upon powering up or encountered a fatal error.

## LED Indicator

The LED indicator **A** shows the operational status of your radio.

<b>Solid yellow (Conventional Only)</b>	Channel is busy.
<b>Blinking yellow</b>	Radio is receiving a secured transmission.
<b>Solid green</b>	Radio is powering up, or is on a non-priority channel while in the Scan List Programming mode.
<b>Blinking green</b>	Radio is receiving an individual or telephone call, or is on a Priority-Two channel while in the Scan List Programming mode.
<b>Rapidly blinking green</b>	Radio is on a Priority-One channel while in the Scan List Programming mode.

**Note:**

No LED indication when the radio receives a clear (non-secured) transmission in trunking Mode. LED indication can be preprogrammed by qualified technician to be permanently disabled. Consult your dealer for further details if you want to disable it.

## Top Lightbar Indicator

---

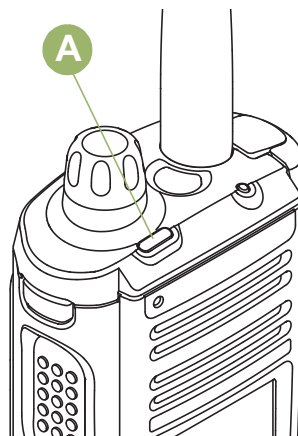

The Top Lightbar **A** indicates the secondary function of MFK and also the status of Intelligent Lighting.

The lightbar blinks green when the MFK is using the secondary feature. See [Multi-Function Knob \(MFK\)](#) on page 28 to understand the functionality of MFK.

The lightbar turn into solid color of orange, red or green depending on the status of Intelligent Lighting. See [Intelligent Lighting Indicators](#) on page 34 for different status of Intelligent Lighting.

## Intelligent Lighting Indicators

This feature temporarily changes the color of the **Top Lightbar** and adds a color bar to the main display screen to help signal that a radio event has occurred.



**Note:**

This feature must be preprogrammed by a qualified radio technician.

Backlight and Bar Color	Notification	When
<b>Orange</b>	<b>Emergency Alerts</b>	The radio initiates an emergency alarm or call.
		The radio receives an emergency alarm or call.
		The radio is out of range.
		The radio enters Fail-soft mode.
		The radio is unable to establish a full connection with the system.
		The radio lost GPS signal or GPS function fails.

Backlight and Bar Color	Notification	When
<b>Green</b>	<b>Call Alerts</b>	The radio receives a private call.
		The radio receives a phone call.
		The radio receives a call alert.
		The radio receives a selective call.
		The radio enters Geofence.

## Alert Tones

Your radio uses alert tones to inform you of the condition of your radio. The following table lists these tones and when they occur.

You Hear	Tone Name	Heard
<b>Short, Low-Pitched Tone</b>	<b>Radio Self Test Fail</b>	When radio fails its power-up self test.
	<b>Reject</b>	When an unauthorized request is made.
	<b>Time-Out Timer Warning</b>	Four seconds before time out.
	<b>No ACK Received</b>	When radio fails to receive an acknowledgment.
	<b>Individual Call Warning Tone</b>	When radio is in an individual call for greater than 6 seconds without any activity.

You Hear	Tone Name	Heard
<b>Long, Low-Pitched Tone</b>	<b>Time-Out Timer Timed Out</b>	After time out.
	<b>Talk Prohibit/PTT Inhibit</b>	(When <b>PTT</b> button is pressed) transmissions are not allowed.
	<b>Lack of Voice PTT Time out</b>	When the radio ends your call after it detected there are lack of voice for 5 seconds after the PTT is pressed and hold. Your radio ends the call to enable your radio to receive calls from other radio users.
	<b>Out of Range</b>	(When <b>PTT</b> button is pressed) the radio is out of range of the system.
	<b>Invalid Mode</b>	When radio is on an unpreprogrammed channel.
<b>A Group of Low-Pitched Tones</b>	<b>Busy</b>	When system is busy.
<b>Short, Medium-Pitched Tone</b>	<b>Valid Key-Press</b>	When a correct key is pressed.
	<b>Radio Self Test Pass</b>	When radio passes its power-up self test.
	<b>Clear Voice</b>	At beginning of a non-coded communication.
	<b>Priority Channel Received</b>	When activity on a priority channel is received.
	<b>Emergency Alarm /Call Entry</b>	When entering the emergency state.



You Hear	Tone Name	Heard
	<b>Central Echo</b>	When central controller has received a request from a radio.
<b>Long, Medium-Pitched Tone</b>	<b>Volume Set</b>	When volume is changed on a quiet channel.
	<b>Emergency Exit</b>	When exiting the emergency state.
<b>A Group of Medium-Pitched Tones</b>	<b>Failsoft</b>	When the trunking system fails.
	<b>Automatic Call Back</b>	When voice channel is available from previous request.
	<b>Keyfail</b>	When encryption key has been lost.
	<b>Console Acknowledge</b>	When status, emergency alarm, or reprogram request ACK is received.
	<b>Received Individual Call</b>	When Call Alert or Private Call is received.
	<b>Site Trunking</b>	When a SmartZone trunking system fails.
<b>Short, High-Pitched Tone (Chirp)</b>	<b>Low-Battery Chirp</b>	When battery is below preset threshold value.
<b>Two High-Pitched Tones</b>	<b>GPS Fails</b>	When the GPS signal is lost or when GPS fails.
<b>Ringing</b>	<b>Phone Call Received</b>	When a land-to-mobile phone call is received.
<b>Gurgle</b>	<b>Dynamic Regrouping</b>	(When <b>PTT</b> button is pressed) a dynamic ID has been received.

You Hear	Tone Name	Heard
	<b>Talk Permit</b>	(When <b>PTT</b> button is pressed) is verifying with the system for accepting its transmissions.
<b>Unique Low-High Tone</b>	<b>MFK Enters Secondary Feature</b>	When <b>MFK</b> is toggled to enter Secondary Feature
<b>Unique High-Low Tone</b>	<b>MFK Exits Secondary Feature</b>	When <b>MFK</b> is toggled to exit secondary feature and return to primary feature.

## Phone Call Displays and Alerts

The following phone call displays and alerts appears on the radio's display when you make and receive Phone calls. The radio also uses alert tones to indicate the current status.

You Hear	You See	When	Notes
<b>A Busy Tone</b>	<b>Phone busy</b>	<b>When a channel is not available.</b>	The radio automatically connects when a channel opens.
<b>A High- Pitched Tone</b>	<b>–</b>	<b>When you release the PTT button.</b>	The radio indicates to the landline party that he or she may begin talking.

## General Radio Operation

### Selecting a Zone

Your radio must be preprogrammed to allow you to use this feature.

A zone is a group of channels. The following methods are options on how to select a radio zone. The result of all the methods is the same. You can use the options interchangeably depending on your preference and the programmed functions.

- Turn the preprogrammed **Zone Change MFK** to the required zone.

If **Mode Change** is secondary feature of the **MFK**, press the **MFK** once to toggle to **Zone Change MFK** then only select the required zone.

- Select a zone via the radio menu `ZnUp` or `ZnDn`:
  - a) Press and hold the **Menu Select** button directly below `ZnUp` or `ZnDn` until the required zone appears.  
Positions of `ZnUp` and `ZnDn` on the display may differ each time you release the **Menu Select** button. Read carefully before you press.

- b) Press the **PTT** button to transmit on the displayed zone channel.

### Selecting a Radio Channel

A channel is a group of radio characteristics, such as transmit/ receive frequency pairs. The following methods are options on how to select a radio channel. The result of all the methods is the same. You can use the options interchangeably depending on your preference and the programmed functions.

- Select a channel via the **MFK**:
  - a) If channel is set as the primary mode, turn the **MFK** until the display shows the desired channel.  
If channel is not set as the primary mode, press the **MFK** once and repeat this step.
  - b) Press the **PTT** button to begin transmitting on the displayed channel.
- Select a channel via the radio menu `Channel Up` or `Channel Down`:
  - a) Press the **Menu Select** button directly below `ChUp` or `ChDn`.

Positions of ChUp and ChDn on the display may differ each time you release the **Menu Select** button. Read carefully before you press.

- b) Press the **PTT** button to transmit on the displayed zone and channel.

- 1 Toggle your zone and channel to the required zone and channel.
- 2 Press and hold the **Menu Select** button directly below one of the softkey (MS1 – MS5).

You hear a short, medium-pitched tone when the zone and channel is saved.



**Note:**

To change the programmed zone and channel, repeat this procedure.

Short press of the programmed softkey changes your current transmission to the zone and channel programmed in this softkey.

## Mode Select Feature

Mode Select allows a long press to save the current zone and channel of your radio to a programmable button, or a softkey; then once programmed, the short-press of that button or softkey changes the transmission to the saved zone and channel.

There are two methods to save the selected zone and channel:

- Softkeys
- Programmable buttons



**Note:**

Your radio must be preprogrammed to allow you to use this feature.

### Saving a Zone and a Channel to a Softkey

Five softkeys are available for you to save the frequently used zone and channel.

### Saving a Zone and a Channel to a Button

You can save the frequent used zone and channel to the programmable buttons.

- 1 Toggle your zone and channel to the required zone and channel.
- 2 Press and hold the button you desire to program.

You hear a short, medium-pitched tone when the zone and channel is saved.

**Note:**

Repeat this procedure to change the zone and channel of the programmed button.

Short press of the programmed button changes your current transmission to the zone and channel programmed in this button.

## Receiving and Responding to a Radio Call

---

Once you have selected the required channel and/or zone, you can proceed to receive and respond to calls.

The LED lights up solid red while the radio is transmitting. In conventional mode, the LED lights up solid yellow when the radio is receiving a transmission. In trunking mode, there is no LED indication when the radio receives a transmission.

If the radio is receiving a secure transmission, the LED blinks yellow.

### Receiving and Responding to a Talkgroup Call

To receive a call from a group of users, your radio must be configured as part of that talkgroup.

When you receive a talkgroup call (while on the Home screen) the radio triggers for your attention with

one of the following scenarios depending on the system your radio is configured:

- For ASTRO Conventional system, the LED lights up solid yellow. The display shows the talkgroup alias or ID, and the caller alias or ID.
- For Trunking system, the display shows the caller alias or ID.

**1** Hold the radio vertically 1 to 2 inches (2.5 to 5.0 cm) from your mouth.

---

**2** Press the **PTT** button to respond to the call. The LED lights up solid red.

---

**3** Release the **PTT** button to listen.

---

### Receiving and Responding to a Private Call (Trunking Only)

A Private Call is a call from an individual radio to another individual radio.

The one-to-one call between the two radios are not heard by the others in the current talkgroup. The calling radio automatically verifies that the receiving radio is active on the system and can display the caller ID.

**Note:**

With the inactivity timer enabled (optional), when there is no response from the receiving radio, the calling radio exits the call with Menu Inactive Exit tone after the timer expires.

When you receive a Private Call, you hear two alert tones and the LED blinks green. The display shows `Call received` and the call received icon blinks.

- 1 Perform one of the following actions:
  - Press the **Menu Select** button directly below `Resp.`
  - Press the **Call Response** button within 20 seconds after the call indicators begin.

If the caller alias is in the call list, the display shows the caller alias during the call.

If the caller name is not in the call list, the display shows the caller ID.

- 
- 2 Press and hold the **PTT** button to talk. Release the **PTT** button to listen.
- 
- 3 Press or the **Call Response** button to hang up and return to the Home screen.
- 

You cannot initiate a Private Call.

## Receiving and Responding to a Telephone Call (Trunking Only)

This feature allows you to receive calls similar to standard phone calls from a landline phone.

**Note:**

With the inactivity timer enabled (optional), if there is no response to the call after the timer expires, your radio exits the call with Menu Inactive Exit tone.

When you receive a Telephone Call, you hear a telephone-type ringing and the LED blinks green. The display shows `Phone Call` and the call received icon blinks.

- 1 Press the **Call Response** button within 20 seconds after the call indicators begin.
- 
- 2 Press and hold the **PTT** button to talk. Release the **PTT** button to listen.
- 
- 3 Press the **Call Response** button to hang up and return to the Home screen.
- 

You cannot initiate a Telephone Call.

## Switching Between Repeater or Direct Operation Button

---

The **Repeater Operation** increases the radio coverage area by connecting with other radios through a repeater. The transmit and receive frequencies are different.

The **Direct** or “talkaround operation” allows you to bypass the repeater and connect directly to another radio. The transmit and receive frequencies are the same.

Perform one of the following actions:

- Press the preprogrammed **Repeater/Direct** switch to toggle between talkaround and repeater modes.
- or to **Dir** and press the **Menu Select** button directly below **Dir**.

---

The display shows `Repeater mode` if the radio is currently in Repeater mode.

The display shows `Direct mode` and the Talkaround icon if the radio is currently in Direct mode (during conventional operation only).

## Monitor Feature

---

Radio users who switch from analog to digital radios often assume that the lack of static on a digital channel is an indication that the radio is not working properly. This is not the case.

Digital technology quiets the transmission by removing the noise from the signal and allows only the clear voice or data information to be heard.

Use the Monitor feature to make sure a channel is clear before transmitting.

### Monitoring a Channel

The following methods are options on how to monitor a channel. The result of all the methods is the same. You can use the options interchangeably depending on your preference and the programmed functions.

- Monitoring a Channel with **Monitor** button.
  - a) Press the preprogrammed **Monitor** button.
  - b) Adjust the **Volume Control Knob** if necessary.
  - c) Press and hold the **PTT** button to transmit. The LED lights up solid red.
  - d) Release the **PTT** button to receive (listen).

The Carrier Squelch indicator appears on the display when you monitor a channel via the preprogrammed **Monitor** button.

---

- Monitoring a Channel via the selected zone channel.
    - a) Select the desired zone and channel.
    - b) Listen for a transmission.
    - c) Adjust the **Volume Control Knob** if necessary.
    - d) Press and hold the **PTT** button to transmit. The LED lights up solid red.
    - e) Release the **PTT** button to receive (listen).
- 

### Monitoring Conventional Mode

Your radio may be preprogrammed to receive Private-Line® (PL) calls.

- 1** Momentarily press the **Monitor** button to listen for activity.  
The Carrier Squelch indicator appears on the display.
- 
- 2** Press and hold the **Monitor** button to set continuous monitor operation.  
The duration of the button press is programmable.
- 

- 3** Press the **Monitor** button again, or the **PTT** button, to return to the original squelch setting.  
If you try to transmit on a receive-only channel, you hear an invalid tone until you release the **PTT** button.
-



## Advanced Features

### Advanced Call Features

---

#### Selective Call (ASTRO Conventional Only)

##### *Receiving a Selective Call*

When you receive a Selective Call, the radio initiates for your attention with one of the following indication scenario:

- You hear two alert tones and the LED lights up solid yellow to indicate the transmitting radio is still sending signal. The call received icons blinks and the display shows `Call received`.
- The LED blinks solid green once to indicate the transmitting radio is pending to receive signal.

The speaker unmutes.

- 1 Hold the radio vertically 1 to 2 inches (2.5 to 5.0 cm) from your mouth.
  - 2 Press and hold the **PTT** button to talk. Release the **PTT** button to listen.
- 

#### Responding to the Dynamic Regrouping Feature (Trunking Only)

This feature allows the dispatcher to temporarily reassign selected radios to a particular channel where they can communicate with each other. This feature is typically used during special operations and is enabled by a qualified radio technician.

You will not notice whether your radio has this feature enabled until a dynamic regrouping command is sent by the dispatcher.



##### **Note:**

If you try to access a zone or channel that has been reserved by the dispatcher as a dynamically regrouped mode for other users, you hear an invalid tone.

When your radio is dynamically regrouped, it automatically switches to the dynamically regrouped channel. You hear a Gurgle tone and the display shows the dynamically regrouped channel's name.

Press the **PTT** button to talk. Release **PTT** button to listen.

---

When the dispatcher cancels dynamic regrouping, the radio automatically returns to the zone and channel

that you were using before the radio was dynamically regrouped.

### ***Requesting a Reprogram (Trunking Only)***

This feature allows you to notify the dispatcher when you want a new dynamic regrouping assignment.

Press the preprogrammed **Reprogram Request** button to send reprogram request to the dispatcher.

The display shows `Reprgrm rqst` and `Please wait`.

---

If you hear five beeps, the dispatcher has acknowledged the reprogram request. The display shows `Ack received` and the radio returns to the **Home** screen.

If the dispatcher does not acknowledge the reprogram request within six seconds, you hear a low-pitched alert tone and the display shows `No acknowledge`. Try again or press to cancel and return to the **Home** screen.

### ***Classification of Regrouped Radios***

The dispatcher can classify regrouped radios into either of two categories:

#### **Select Enabled**

Select-enabled radios are free to change to any available channel, including the dynamic-regrouping channel, once the user has selected the dynamic-regrouping position.

#### **Select Disabled**

Select-disabled radios cannot change channels while dynamically regrouped. The dispatcher has forced the radio to remain on the dynamic-regrouping channel.

The Scan or Private Call feature cannot be selected while your radio is Select Disabled.

---

## **Scan Lists**

Scan lists are created and assigned to individual channels/ groups. Your radio scans for voice activity by cycling through the channel/group sequence specified in the scan list for the current channel/ group.

Your radio supports different types of Scan Lists:

- Trunking Priority Monitor Scan List
- Conventional Scan List
- Talkgroup Scan List

Please refer to a qualified radio technician for the maximum number of Scan Lists can be programmed in your radio. These lists must be preprogrammed by a qualified radio technician.

### Viewing a Scan List

Perform one of the following actions:

- Turn the **MFK** to view the members on the list.
- Turn the **16-Position Select Knob** to view the members on the list.

### Viewing and Changing the Priority Status

Perform one of the following actions:

- Press the **Menu Select** button directly below  $\text{Se1}$  one or more times to change the priority status of the current displayed channel.
- Press the **Select** button one or more times to toggle between different status of the Scan List status icon of the current displayed channel.

The radio shows one of following priority status icons and scenarios:

- A Scan icon indicates that the current channel is in the scan list as a non-priority channel. The LED lights up solid green.
- A Priority-Two Channel Scan icon indicates that the current channel is in the scan list as the Priority-Two channel. The LED blinks green.
- A Priority-One Channel Scan icon indicates that the current channel is in the scan list as the Priority-One channel. The LED rapidly blinks green. You hear all traffic on the Priority-One channel, regardless of traffic on non-priority channels.
- No icon indicates that the current channel is deleted from the scan list.

## Scan

This feature allows you to monitor traffic on different channels by scanning a preprogrammed list of channels.

### Turning Scan On or Off

Perform one of the following actions:

- Press the preprogrammed **Scan** button to toggle `Scan On` or `Scan Off` to initiate or stop scan.
- Press the **Menu Select** button directly below `Scan`.

If the scan is enabled, the display shows `Scan on` and the scan status icon.

If the scan is disabled, the display shows `Scan Off`.

---

The radio returns to the Home screen.

### Making a Dynamic Priority Change (Conventional Scan Only)

While the radio is scanning, the dynamic priority change feature allows you to temporarily change any channel in a scan list (except for the Priority-One channel) to the Priority-Two channel.

This change remains in effect until scan is turned off. Scan then reverts to the preprogrammed (original) setting.

Making a Dynamic Priority Change via the preprogrammed **Dynamic Priority** button:

- a) When the radio locks onto the channel designated as the new Priority-Two channel, press the preprogrammed **Dynamic Priority** button.  
The radio continues scanning the remaining channels in the list.
- 

### Deleting a Nuisance Channel

If a channel continually generates unwanted calls or noise (termed a “nuisance” channel), you can temporarily remove the unwanted channel from the scan list.

This capability does not apply to priority channels or the designated transmit channel.

When the radio is locked onto the channel to be deleted, perform one of the following actions:

- Press and hold the **Menu Select** button below `Scan` or preprogrammed **Scan** button to delete the nuisance channel.
  - Press the preprogrammed **Nuisance Delete** button.
  - Press the **Menu Select** button directly below `Nuis`.
-

The radio continues scanning the remaining channels in the list.

## Restoring a Nuisance Channel

To restore the deleted nuisance channel, perform one of the following actions:

- Stop and restart a scan.
- Mode change to another channel and back to the original channel.
- Turn off the radio and then turn it on again.

Nuisance mode delete can be disabled by the system administrator.

---

## Call Alert Paging

---

This feature allows your radio to work like a pager.

The radio which you missed its call can send a Call Alert page to your radio. The sender also able to know that your radio is active.



**Note:**

This feature must be preprogrammed by a qualified radio technician.

## Receiving a Call Alert Page

When you receive a Call Alert page, you hear four repeating alert tones and the LED blinks green. The call received icons blinks and the display shows Page received.

Press any button to clear the Call Alert page.

---

You cannot send a Call Alert page.

## Emergency Operation

---

The Emergency feature is used to indicate a critical situation.

If the **Top (Orange)** button is preprogrammed to send an emergency signal, this signal overrides any other communication over the selected channel.

Your radio supports the following Emergency modes:

- Emergency Alarm
- Emergency Call (Trunking Only)
- Emergency Alarm with Emergency Call
- Silent Emergency Alarm

Check with your dealer or system administrator for more information on the programming of this feature.

Only **one** of the Emergency modes above can be assigned to the preprogrammed **Emergency** button.



**Note:**

To exit emergency at any time, press and hold the preprogrammed Emergency button for about a second. This timer is programmable from 0 – 6250 milliseconds by a qualified technician.

The radio operates in the normal dispatch manner while in Emergency Call, except if enabled, it returns to one of the following:

**Tactical/Non-Revert**

The radio sends emergency alarm and/or make emergency call on the current selected channel.

**Non-Tactical/Revert for Conventional system**

The radio reverts to the preprogrammed emergency channel to send alarm and/or make emergency call.

**Non-Tactical/Revert for**

The radio reverts to the preprogrammed emergency talkgroup to

**Trunking system**

send alarm and/or make emergency call.

**Sending an Emergency Alarm**

This feature allows you to send a data transmission, which identifies the radio sending the emergency, to the dispatcher.



**Note:**

The default timer of Emergency button press to activate Emergency is 50 milliseconds. This timer is programmable from 50 – 6200 milliseconds by a qualified technician.

Press the preprogrammed **Emergency** button.

One of the following scenarios occurs:

- The display shows **Emergency** and the current zone or channel. You hear a short medium-pitched tone and the LED blinks red momentarily.
- The radio sounds a short low-pitched tone to indicate that the selected channel does not support emergency and rejects to launch emergency mode. The display shows **No**

emergency, if the selected channel does not support emergency.

When you receive the dispatcher's acknowledgment, the display shows **Ack received**. Four tones sound, the alarm ends, and the radio exits the Emergency Alarm mode.

If no acknowledgement is received, the display shows **No acknowledge**. The alarm ends when the timer expires and the radio exits the Emergency Alarm mode.

### Sending an Emergency Call (Trunking Only)

This feature gives your radio priority access to a talkgroup.

- 1 Press the preprogrammed **Emergency** button. One of the following scenarios occurs:
  - The display shows **Emergency** on the current zone and channel. You hear a short medium-pitched tone and the LED blinks red momentarily.
  - You hear the radio sounds a short low-pitched tone to indicate the selected channel does not

support emergency and rejects to launch emergency mode.

- 2 Hold the radio vertically 1 to 2 inches (2.5 to 5.0 cm) from your mouth.
- 3 Press and hold the **PTT** button. Speak clearly into the microphone.
- 4 Release the **PTT** button to end the transmission and wait for a response from the dispatcher.
- 5 To exit Emergency Call, press and hold the preprogrammed **Emergency** button for about a second.

### Sending an Emergency Alarm with Emergency Call

This feature gives your radio priority access on a channel for conventional system, and to a talkgroup for trunking system.

- 1 Press the preprogrammed **Emergency** button.
 

If successful, the display shows **Emergency** on the current zone and channel. You hear a short, medium-pitched tone and the LED blinks red momentarily.

The radio exits Emergency Alarm and enters the Emergency Call state when one of the following scenarios occur:

- You receive the dispatcher acknowledgment. The display shows `Ack received`.
- You receive no acknowledgement. The display shows `No acknowledge`.
- You press the **PTT** button while in the Emergency Alarm mode.

If unsuccessful, you hear the radio sounds a short low-pitched tone to indicate the selected channel does not support emergency and rejects to launch emergency mode.

- 
- 2 Hold the radio vertically 1 to 2 inches (2.5 to 5.0 cm) from your mouth.
- 
- 3 Press and hold the **PTT** button. Speak clearly into the microphone.
- 
- 4 Release the **PTT** button to end the transmission and wait for a response from the dispatcher.
- 
- 5 To exit Emergency Call, press and hold the preprogrammed **Emergency** button for about a second.

Turning off the radio also cancels the emergency state.

---

### Sending a Silent Emergency Alarm

This feature allows you to send an Emergency Alarm to the system without triggering any audio or visual indicators.

- 1 Press the preprogrammed **Emergency** button. The display shows no changes, the LED does not light up, and you hear no tones. The silent emergency state continues until you perform the next step.
- 
- 2 Perform one of the following actions:
    - You press and hold the preprogrammed **Emergency** button for about a second to exit the Silent Emergency Alarm mode.
    - Press and release the **PTT** button to exit the Silent Emergency Alarm mode and enter regular dispatch or Emergency Call mode.

---

### Change of Channels during Emergency

For ALL Emergency transmissions, when changing channels:



- If the new channel is also preprogrammed for Emergency, you can change channels while in Emergency operation. The emergency alarm or call continues on the new channel.
- If the new channel is **not** preprogrammed for Emergency, the display shows *No emergency*, and you hear an invalid tone until you exit the Emergency state or change to a channel preprogrammed for Emergency.

### Emergency Keep-Alive Feature

This feature, when enabled, prevents the radio from being turned off via the **MFK** when the radio is in the Emergency state.



#### Note:

The radio only exits the Emergency state using one of the ways mentioned in the previous sections.

See [Sending an Emergency Alarm](#) on page 50, [Sending an Emergency Call \(Trunking Only\)](#) on page 51, [Sending an Emergency Alarm with Emergency Call](#) on page 51, or [Sending a Silent Emergency Alarm](#) on page 52.

## Fireground (Conventional Only)

---

The portable Fireground Communications System is designed for deployment at an incident scene. It consists of five central components:

- Your APX portable radios
- Incident Management Software
- Command Terminal
- Radio Frequency (RF) Modem
- DVRS (Optional)

These components provide on-scene and inbuilding radio coverage, and enhanced personnel accountability and monitoring.

The radio helps to indicate your presence on the scene if it is in the range of the Incident Commander command terminal.

Each Fireground Communication System radio automatically reports your radio ID on the commander mobile command terminal. Your name, riding position and sector are all can be configured to be seen at the Commander's command terminal.

If you have a critical situation, you can press the Emergency button which activates an alarm on the

Incident Management Software at the command terminal.

The Fireground signals transmission is always exchanging data between your radio and the RF Modem and command terminal. The status of your radio includes:

- Powering up or down the radio
- Automatic response to Polling
- Response to Evacuation commands
- Pressing the **PTT** button to make voice transmission
- Sending an Emergency Alarm and Call

### Entering Fireground Zone Channel

- 1 Upon powering up, perform one of the following actions:
  - If the Fireground Zone Channel is set as default, you hear gurgle tone and the home screen. You are in Fireground zone channel.
  - Get a qualified technician for assistance.
  - If your home channel is not Fireground Zone Channel, toggle or change the radio zone channel to Fireground Zone Channel.

- 2 Listen for a transmission. Adjust the **Volume Control Knob** if necessary.

- 3 Perform one of the following actions:

- Press and hold the preprogrammed **Volume Set** button to hear the volume set tone. Adjust the **Volume Control Knob** if necessary. Release the **Volume Set** button.
- At the desired Fireground zone and channel, press the preprogrammed **Monitor** button and listen for activity. Adjust the **Volume Control Knob** if necessary.
- If your radio is working in Fireground Zone Channel, proceed to next step.

- 4 Press and hold the **PTT** button to transmit. The LED lights up solid **red** while transmitting. Talk into the microphone clearly if needed.

- 5 Release the **PTT** button to receive. You hear a Transmit End Tone.

### Responding to Evacuation Indicator

When Incident Commander triggers Evacuation signal from his command terminal, the RF Modem

updates everyone in the Fireground Communication System with the order to evacuate the incident site.

Your radio sounds the Evacuation Tone at the profile maximum alert tone volume level. The display shows EVACUATE.

Perform one of the following actions:

- Move the **Volume Control Knob** to adjust the volume of the Evacuation Tone from full volume.
- Perform any action on the radio other than volume adjustments to cancel the evacuation indications and update the command terminal.
- If preprogrammed with Manual Acknowledgement of Evacuation Command, pressing the **PTT** button shall cancel the indications and acknowledge the command terminal.

Data applications within the fixed network can determine the presence of a device on the system and send data to the device.

The Automatic Registration Service for the radio consists of two (2) modes:

- ARS Server Mode (default mode)
- ARS Non-Server Mode



**Note:**

The default ARS mode can be changed by a qualified radio technician using the radio's programming software.

### Selecting or Changing the ARS Mode

The following methods are options on how to select or change the ARS Mode. The result of all the methods is the same. You can use the options interchangeably depending on your preference and the programmed functions.

- Selecting or Changing the ARS mode via the **MFK**:
  - a) Once the zone you want is displayed, turn the preprogrammed **MFK** to the desired mode.

## Automatic Registration Service (ARS)

This feature provides an automated data application registration for the radio. When you turn on the radio, the device automatically registers with the server.

- Selecting or Changing the ARS mode via the radio menu:
  - a) or to Chan.
  - b) Press the **Menu Select** button directly below Chan.  
The display shows the current channel name.
  - c) or to the required channel or mode.  
One of the following scenarios occur:
    - In ARS Server Mode, the display shows the zone and ARS server channel.
    - In ARS Non-Server Mode, the display shows the zone and ARS non-server channel.
    - If the channel or mode selected is unprogrammed, the display shows Unprogrammed. Repeat this step.
  - d) Press **Sel** to confirm the displayed channel.

---

## Secure Operations

---

Secure radio operation provides the highest commercially available level of voice security on both trunked and conventional channels.

Unlike other forms of security, Motorola digital encryption provides signaling that makes it virtually impossible for others to decode any part of an encrypted message.

## Selecting Secure Transmissions

Turn the preprogrammed **Secure/Clear** switch to the secure position.



### Note:

If the selected channel is preprogrammed for clear-only operation, when you press the **PTT** button, you hear an invalid mode tone and the display shows `Clear TX only`.

The radio does not transmit until you set the **Secure/Clear** switch to the clear position.

If the “Ignore **Secure/Clear** Switch when Strapped” programming option is enabled, the radio transmits without displaying any messages in the strapped mode of operation, regardless of the **Secure/Clear** switch setting. This option must be preprogrammed by a qualified radio technician.

The **Secure/Clear** switch only applies when the radio is transmitting.

---

## Selecting Clear Transmissions

Turn the preprogrammed **Secure/Clear** switch to the clear position.



### Note:

If the selected channel is preprogrammed for secure-only operation, when you press the **PTT** button, you hear an invalid mode tone and the display shows `Secure TX only`.

The radio does not transmit until you set the **Secure/ Clear** switch to the secure position.

You can request to configure the radio to ignore the clear voice or insecured transmission when the radio is in secured transmission. Check with your agent for details.

If the “Ignore **Secure/Clear** Switch when Strapped” programming option is enabled, the radio transmits without displaying any messages in the strapped mode of

operation, regardless of the **Secure/Clear** switch setting. This option must be preprogrammed by a qualified radio technician.

The **Secure/Clear** switch only applies when the radio is transmitting.

---

## Managing Encryption

### *Loading an Encryption Key*



### Note:

Refer to the key-variable loader (KVL) manual for equipment connections and setup.

- 1 Attach the KVL to your radio.  
The display shows `Keyloading`, and all other radio functions, except for power down, backlight, and volume, are locked out.
- 
- 2 Select the required keys and press the **Menu Select** button directly below `LOAD` on the KVL.  
This loads the encryption keys into your radio.

When the key has been loaded successfully, one of the following scenarios occurs:

- You hear the radio sounds a short tone for single-key radios.
- You hear the radio sounds an alternating tone for multikey radios.

The KVL indicates that keyload is successful.

### ***Multikey Feature***

This feature allows the radio to be equipped with different encryption keys and supports the DES-OFB algorithm.

There are two types:

**Conventional Multikey** The encryption keys can be tied (strapped), on a one-per-channel basis, through Customer Programming Software. In addition, you can have operator-selectable keys, operator-selectable keysets, and operator-selectable key erasure. If talkgroups are enabled in conventional, then the encryption keys are strapped to the talkgroups.

**Trunked Multikey** If the radio is used for both conventional and trunked applications, strap the encryption

keys for trunking on a per-talkgroup or announcement-group basis. In addition, a different key can be strapped to other features, such as dynamic regrouping, failsoft, or emergency talkgroup. You can have operator-selectable key erasure.

### ***Erasing the Selected Encryption Keys***

This feature allows you to erase all or selected encryption keys.

Erasing the single key in radios with the single-key option and erasing all keys in radios with the multikey option via the preprogrammed **Top Side (Select)** button and **Top (Orange)** button:

- a) Press and hold the **Top Side (Select)** button.
- b) While holding **Top Side (Select)** button down, press the **Top (Orange)** button. The display shows `Please wait`. When all the encryption keys have been erased, the display shows `All keys erased`.

**Note:**

Do **not** press the **Top (Orange)** button before pressing the **Top Side (Select)** button, unless you are in an emergency situation as this sends an emergency alarm.

**Hear Clear****Note:**

This feature must be preprogrammed by a qualified radio technician. Check with your dealer or system administrator for more information.

There are two components of Hear Clear.

**Companding** Reduces the channel noise, e.g. OTA transmission, that is predominantly present in UHF2 and 900 MHz channel with the following features.

**Compressor** Reduces the background noise flow and the speech signal at transmitting radio.

**Expander**

Expands the speech while the noise flow remains the same at receiving radio.

**Random FM Noise Canceller (Flutter Fighter)**

Reduces the unwanted effects of random FM noise pulses caused by channel fading under high Signal-to-Noise (S/N) conditions such as in a moving transportation. The fading effects, heard as audio pops and clicks, are cancelled without affecting the desired audio signal.

The Random FM Noise Canceller operates only in receive mode.

**Trunking System Controls****Operating in Failsoft System**

The failsoft system ensures continuous radio communications during a trunked system failure. If a trunking system fails completely, the radio goes into failsoft operation and automatically switches to its failsoft channel.

During failsoft operation, your radio transmits and receives in conventional operation on a predetermined frequency. You hear a medium-pitched tone and the display shows `Failsoft`.

When the trunking system returns to normal operation, your radio automatically leaves failsoft operation and returns to trunked operation.

To continue, in Failsoft, to communicate with other talkgroups, refer to the following procedure.

- 1 Rotate the **Mode Knob** to change to a different repeater frequency.
- 
- 2 Press the **PTT** button to talk, and release the button to listen.
- 

### Out-of-Range Radio

When your radio goes out of the range of the system, it can no longer lock onto a control channel.

You hear a low-pitched tone and/or the display shows the currently selected zone/channel combination and `Out of range`. Your radio remains in this out-of-range condition until it locks onto a control channel, it locks onto a failsoft channel, or it is turned off.

### Site Trunking Feature

If the zone controller loses communication with any site, that site reverts to site trunking.

The display shows the currently selected zone/channel combination and `Site trunking`.



#### Note:

When this occurs, you can communicate only with other radios within your trunking site.

### Locking and Unlocking a Site

This feature allows your radio to lock onto a specific site and not roam among wide-area talkgroup sites. This feature should be used with caution, since it inhibits roaming to another site in a wide-area system.

You can toggle the lock state between locked and unlocked by pressing the preprogrammed **Site Lock/Unlock** button.

Follow the following procedure to lock and unlock a site via the radio menu.

- 1 Press the **Menu Select** button directly below `Site`.
-



- 2 Perform one of the following actions:
- To lock the site, press the **Menu Select** button directly below **Lock**. The display shows **Site locked**.
  - To unlock the site, press the **Menu Select** button directly below **Unlk**. The display shows **Site unlocked**.

---

The radio saves the new site lock state and returns to the Home screen.

### Site Display and Search Button

The **Site Display** and **Site Search** button allows you to view the name of the current site or force your radio to change to a new one.

#### Viewing the Current Site

Perform one of the following actions:

- Press the preprogrammed **Site Displ/Srch** button.
  - Press the **Menu Select** button directly below **RSSI**.
- 

The display shows momentarily the name of the current site and its corresponding received signal strength indicator (RSSI).

#### Changing the Current Site

Perform one of the following actions:

- Press and hold down the preprogrammed **Site Displ/Srch** button.
- Press and hold down the **Menu Select** button directly below **RSSI**.

You hear a tone and the display shows momentarily **Scanning site**.

---

When the radio finds a new site, it returns to the Home screen.

### Over-the-Air Programming (POP 25, ASTRO 25, ASTRO Conventional)

---

This feature enables configuration data and firmware to be upgraded to your radio over-the-air. Full use of the radio is retained during the data transfer without interrupting communication. For ASTRO 25 and ASTRO Conventional, the upgrade pauses to give priorities to voice call, and continues after the voice

call ended. For Wi-Fi®, the upgrade process runs concurrently with voice calls.

Once a configuration upgrade is downloaded to your radio, you can install new changes immediately or delay changes to be installed on the radio when it is being powered up.



**Note:**

This feature must be preprogrammed by a qualified radio technician. Check with your dealer or system administrator for more information.

## Responding to the Notification of Upgrade

- 1 The display shows Upgrade? and two short, medium- pitched tones sounds every 30 seconds until the user makes a choice of accepting, delaying, or rejecting the request
- 2 Perform one of the following actions:
  - Press the **Menu Select** button below Acpt to accept the request to upgrade immediately.
  - Press the **Menu Select** button below Delay to delay the request to upgrade.

- Press the **Menu Select** button below Rej to reject the request to upgrade.

---

One of the following scenarios occurs:

- If you choose to accept, the display shows Programming Dont power off to indicate the upgrade is about to begin. The radio resets to install the upgrade. In the case of configuration data upgrade, this process only takes a few seconds. In the case of firmware upgrade, the installation takes several minutes.



**Note:**

The radio cannot be used while the upgrade is being installed. Therefore, make sure to only accept the upgrade at a convenient time when immediate radio use is not required.

- If you choose to delay, a configuration data upgrade is installed automatically at the next power up. However, in the case of a firmware upgrade, the radio prompts Upgrade? again at the next power up.
- If you choose to reject, the display shows Upg Aborted. The radio continues to function with the current configuration until it gets reprogrammed.

**Note:**

If your radio has problems upgrading over-the-air, consult a qualified technician for details.

## Voice Announcement

---

This feature enables the radio to audibly indicate the current feature mode, zone or channel the user has just assigned. This audio indicator can be customized per customer requirements. This is typically useful when the user is in a difficult condition to read the content shown on the display.

Each voice announcement is within a limit of three seconds maximum. The sum duration of all different voice announcements in a radio shall be no more than 1000 seconds.

**Note:**

This feature must be preprogrammed by a qualified radio technician.

Check with your agent if Voice Announcement is available for the feature you need.

The two options of priority for the Voice Announcement available are:

**High** Enables the voice of the feature to announce even when the radio is receiving calls.

**Low** Disables the voice of the feature from announcing when the radio is receiving calls.

You hear a voice announcement when the features below are preprogrammed in the radio.

- The radio powers up. The radio announces the current zone and channel it is transmitting.
- Press the preprogrammed voice announcement button (which specifically programmed to playback the current zone and channel). The radio announces the current zone and channel it is transmitting.

**Note:**

Pressing this preprogrammed playback button enables the voice feature to announce in High priority.

All the three programmable buttons at the side of the radio support this feature.

- Change to a new zone. The radio announces the current zone and channel it is transmitting.

- Change to a new channel remaining within the current zone. The radio announces the current channel.
- Press either the **Menu Select** button or preprogrammed button of the radio to launch or terminate Scan, PL Disabled, Talkaround/Direct or Transmit Inhibit. The radio announces the corresponding feature activation or deactivation.

## Site Selectable Alerts (ASTRO 25)

---

A Site Selectable Alert (SSA) is an Intelligent Lighting indicator together with audio alert sent to radios at a site or a few sites to notify the users when there is a special situation that they need to be aware of. Only authorized radios are enabled to send SSA.

Upon the activation of a SSA, the receiving radios display the alert alias and generate the periodic alert tone.



### Note:

Alert alias, alert tone, and alert period can be preprogrammed. Alert period is the duration for the radio to repeat the alert tone. An interval of 5 seconds might impact the battery life of the radio. Check with your dealer or system administrator for more details.

When mixing SSA with received voice audio, the SSA alert is reduced in volume to ensure that the voice message is still heard clearly. Therefore, it is important that the SSA audio files are created with clear loud audio to ensure they can still be heard clearly when played at reduced levels.

## Utilities

---

### Selecting the Power Level



### Note:

This feature must be preprogrammed by a qualified radio technician.

This feature enables you to reduce the transmit power level for specific case that requires a lower power level. You can select the power level at which your radio transmits. The radio always turns on to the default setting. These reduced transmit power level settings do not affect the receiving performance of your radio, nor diminish the overall quality of the audio and data functionality of the radio given the following conditions.

Power level **Low** enables a shorter transmitting distance and to conserve power. Power level **High** enables a longer transmitting distance.

The following methods are options on how to select the power level. The result of all the methods is the same. You can use the options interchangeably depending on your preference and the programmed functions.

- Selecting the Power Level via the **Transmit Power Level** switch:
    - a) Use the preprogrammed **Transmit Power Level** switch to toggle the power level between low and high power.
- 
- Selecting the Power Level via the radio menu:
    - a) Press the **Menu Select** button directly below **Pwr.**
- 

The display shows **Low power** and the low power icon or the display shows **High power** and the high power icon.

### Enabling and Disabling the Radio Alias

This feature allows you to display or hide the radio alias (name).

Press the **Menu Select** button directly below **MyID**.

---

The display shows momentary **Radio ID off**, and the radio alias disappears from the Home screen or the display shows momentary **Radio ID on**, and the radio alias appears on the Home screen.

### Controlling the Display Backlight

You can enable or disable the radio's display backlight as needed, if poor light conditions make the display or keypad difficult to read.

Depending on how your radio is preprogrammed, you can also maintain a minimum backlight level on the radio's front display.



#### Note:

The backlight setting also affects the **Menu Select** buttons backlighting accordingly.

The backlight remains on for a preprogrammed time before it automatically turns off completely or returns to the minimum backlight level.

Perform one of the following actions:

- To toggle the backlight on or off, press the preprogrammed **Light/Flip** button.
- To turn the backlight on, press either the **Menu Select** buttons or any programmable radio controls or buttons.

---

## Locking and Unlocking the Controls

You can lock your radio programmable buttons and MFK to avoid inadvertent entry. Check with your dealer or qualified technician for best selection to suit your usage.

- 1 Toggle the preprogrammed **Keypad/Control Lock** button to on.  
The display shows `Kypd/Ctrl Lock`.

- 2 Toggle again to unlock the controls.

---

## Turning the Controls and Buttons Tones On or Off

You can enable and disable the tones of Navigation buttons and controls if needed.

- Turning the tones on or off via the preprogrammed **Mute** button:
  - a) To turn the tones off or on, press the preprogrammed **Mute** button.

- Turning the tones on or off via the radio menu:
  - a) Press the **Menu Select** button directly below `Mute`.  
The display shows momentary `Tones off`, indicating that the tones are disabled or the display shows momentary `Tones on`, and you hear a short tone indicating that the tones are enabled.

---

## Turning Voice Mute On or Off

You can enable and disable voice transmission, if needed.

- Turning Voice Mute off or on via the preprogrammed **Voice Mute** button:
  - a) To turn the feature off or on, press the preprogrammed **Voice Mute** button.
- Turning Voice Mute on or off via the radio menu:
  - a) Press the **Menu Select** button directly below `VMut`.

---

The display shows momentary `Voice mute off`, and you hear a short tone, indicating that the feature is disabled or the display shows momentary `Voice`

mute on, and you hear a short tone, indicating that the feature is enabled.

### Using the Time-Out Timer

This feature turns off the transmitter of your radio. You cannot transmit longer than the preset timer setting.

If you attempt to do so, the radio automatically stops your transmission, and you hear a talk-prohibit tone.

The timer is defaulted at 60 seconds, but it can be preprogrammed from 3 to 120 seconds, in 15-second intervals, or it can be disabled entirely for each radio mode, by a qualified radio technician.



#### Note:

You hear a brief, low-pitched, warning tone four seconds before the transmission times out.

- 1 Hold down the **PTT** button longer than the preprogrammed time.  
You hear a short, low-pitched warning tone, the transmission is cut-off, and the LED goes out until you release the **PTT** button.

---

- 2 Release the **PTT** button.

The timer resets.

- 3 To re-transmit, press the **PTT** button.  
The time-out timer restarts and the LED lights up solid red.

### Using Conventional Squelch Operation Features

This feature filters out unwanted calls with low signal strength or channels that have a higher than normal background noise.

#### Analog Options

Tone Private Line (PL), Digital Private-Line (DPL), and carrier squelch can be available (preprogrammed) per channel.

Mode	Result
Carrier squelch (C)	You hear all traffic on a channel.
PL or DPL	The radio responds only to your messages.

## Digital Options

One or more of the following options may be preprogrammed in your radio. Check with your dealer or system administrator for more information.

Option	Result
Digital Carrier-Operated Squelch (COS)	You hear any digital traffic.
Normal Squelch	You hear any digital traffic having the correct network access code.
Selective Switch	You hear any digital traffic having the correct network access code and correct talkgroup.

### Using the PL Defeat Feature

This feature allows you to override any coded squelch (DPL or PL) that might be preprogrammed to a channel. The radio also unmutes to any digital activity on a digital channel.

Place the preprogrammed **PL Defeat** switch in the PL Defeat position.

One of the following scenarios occurs:

- You hear any activity on the channel.
- The radio is muted if no activity is present.



#### Note:

When this feature is active, the Carrier Squelch status indicator is displayed.

### Digital PTT ID Support

This feature allows you to see the radio ID (number) of the radio from whom you are currently receiving a transmission. This ID, consisting up to a maximum of eight characters, can be viewed by both the receiving radio and the dispatcher.

The ID number of your radio is also automatically sent every time the **PTT** button is pressed. This is a per-channel feature. For digital voice transmissions, the ID of your radio is sent continuously during the voice message.

### Smart PTT Feature (Conventional Only)

Smart **PTT** is a per-personality, programmable feature used in conventional radio systems to keep radio users from talking over other radio conversations.



When smart **PTT** is enabled in your radio, you cannot transmit on an active channel.

If you try to transmit on an active smart-**PTT** channel, you hear an alert tone, and the transmission is inhibited. The LED lights up solid yellow to indicate that the channel is busy.

The following table shows the variations of smart **PTT**:

Mode	Description
Transmit Inhibit on Busy Channel with Carrier	You cannot transmit if any traffic is detected on the channel.
Transmit Inhibit on Busy Channel with Wrong Squelch Code	You cannot transmit on an active channel with a squelch code or (if secure-equipped) encryption key other than your own. If the PL code is the same as yours, the transmission is not prevented.
Quick-Key Override	Your radio must be preprogrammed to allow you to use Quick-Key Override. This feature can work in conjunction with either of the two above variations. You

Mode	Description
	can override the transmit-inhibit state by quick-keying the radio. In other words, two <b>PTT</b> button presses within the preprogrammed time limit.

### Viewing the IP Address

This feature displays the IP address.

#### 1 Perform one of the following actions:

- Press the preprogrammed **IP** button.
- Press the **Menu Select** button directly below IP.

The display shows the IP Address screen.

#### 2 Press **Exit** to return to the Home screen.

### Transmit Inhibit

This feature is available for APCO 25 trunking, Type II trunking and Conventional operations for all APX radios.

When Transmit Inhibit feature is enabled, the radio stops all transmission including voice and data. The radio could receive messages but not replying the acknowledgement request of the received message.

User could physically control the transmission of the radio especially during operation in hazardous environments with this feature. An environment is considered hazardous when the power emitted by the radio power amplifier could initiate an explosion or other dangerous reactions.

When the Transmit Inhibit feature is disabled, the radio functions according to its normal operations.

The radio sounds alert tone when user enters or exits this feature and also when **PTT** is pressed.

**Note:**

Acknowledgement of any messages required from the radio is not transmitted if the Transmit Inhibition is enabled.

### ***Enabling Transmit Inhibition***

Press the Transmit Inhibit programmable button.

**Note:**

If the user has disabled TX Inhibit via the menu and then moves the switch to the

position where TX Inhibit is enabled, the new value overwrites the menu value.

The display shows `Tx inhibit on`. You hear a sequence of short, low-high tones to indicate transmission is inhibited.

---

Pressing **PTT** triggers the radio sounds a constant short, low-pitched tone (reject tone).

**Note:**

The status of the Transmit Inhibit does not change after the radio powers up.

### ***Disabling Transmit Inhibition***

Press the Transmit Inhibit programmable button.

**Note:**

If the user has disabled TX Inhibit via the softkey and then moves the switch to the position where TX Inhibit is enabled, the new value overwrites the menu value.

The display shows `Tx inhibit off`. You hear a sequence of short, high-low tone (Transmit Inhibit Off tone) to indicate transmission is back to normal operation.

---

## Helpful Tips

### Radio Care



#### Caution:

- Your radio casing has a vent port that allows for pressure equalization in the radio. Never poke this vent **A** with any objects, such as needles, tweezers, or screwdrivers.

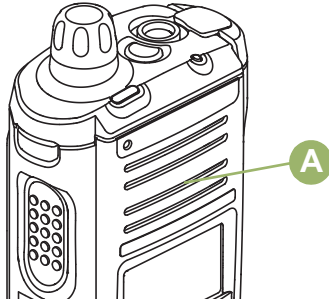

- Do **not** disassemble the radio. This could damage radio seals and result in leak paths into the radio. Any radio

maintenance should be performed only by a qualified radio technician.

### Cleaning Your Radio



#### Caution:

Do **not** use solvents to clean your radio as most chemicals may permanently damage the radio housing and textures.

Do **not** submerge the radio in the detergent solution.

To clean the external surfaces of your radio, follow the procedure described next.

- Combine one teaspoon of mild dishwashing detergent to one gallon of water (0.5% solution).
- Apply the solution sparingly with a stiff, non-metallic, shortbristled brush, making sure excess detergent does not get entrapped near the connectors, controls or crevices. Dry the radio thoroughly with a soft, lint-free cloth.
- Clean battery contacts with a lint-free cloth to remove dirt or grease.

## Proper Ways to Handle the Radio

- Do **not** pound, drop, or throw the radio unnecessarily. Never carry the radio by the antenna.
- Avoid subjecting the radio to an excess of liquids.
- Do **not** submerge the radio.
- Avoid subjecting the radio to corrosives, solvents or chemicals.
- Do **not** disassemble the radio.
-  **Caution:** Do **not** use the radio without an accessory connector or a dust cover in place as contamination can build up on the contacts.

## Radio Service and Repair

Proper repair and maintenance procedures will assure efficient operation and long life for this product. A Motorola maintenance agreement will provide expert service to keep this and all other communication equipment in perfect operating condition. A nationwide service organization is provided by Motorola to support maintenance services. Through its maintenance and installation program, Motorola makes available the finest service to those desiring reliable, continuous communications

on a contract basis. For a contract service agreement, please contact your nearest Motorola service or sales representative, or an authorized Motorola dealer.

## Battery Care

---

### Battery Charge Status

Your radio can indicate the battery's charge status through:

- the LED and sounds.
- the fuel gauge icon on the display.





### *LED and Sounds*

When your battery is low:

- the LED blinks red when the **PTT** button is pressed.
- you hear a low-battery “chirp” (short, high-pitched tone).

### *Fuel Gauge Icons*

A blinking fuel gauge icon () is displayed only when the battery voltage drops to low level. In this case, replace the battery with a fully charged one.

Gauge	Battery Charge
	76% to 100% full <sup>[2]</sup>
	51% to 75% <sup>[2]</sup>
	26% to 50% <sup>[2]</sup>
	11% to 25% <sup>[2]</sup>
	10% or less (at 10%, the gauge begins blinking)

## Battery Recycling and Disposal

In the U.S. and Canada, Motorola participates in the nationwide Rechargeable Battery Recycling Corporation (RBRC) program for battery collection and recycling. Many retailers and dealers participate in this program.

For the location of the drop-off facility closest to you, access RBRC's Internet web site at [www.rbrc.com](http://www.rbrc.com) or call 1-800-8-BATTERY. This internet site and telephone number also provide other useful information concerning recycling options for consumers, businesses, and governmental agencies.

<sup>2</sup> These are for IMPRES™ battery operation only.

---

## Accessories

The accessory link below is for APX radios. Not all accessories are FCC certified to operate with all APX models and/or bandsplits. Please refer to the specific APX radio price pages for a list of FCC certified accessories or contact your sales representative for accessory compatibility.

<http://www.motorolasolutions.com/APX>



**Note:**

Only the following programming cables are compatible with the radios.

- APX DMR Port Programming Cable (PMKN4012B)
- Test and Alignment Programming Cable (PMKN4013C)

## Maritime Radio Use in the VHF Frequency Range

### Special Channel Assignments

---

#### Emergency Channel

If you are in imminent and grave danger at sea and require emergency assistance, use VHF Channel 16 to send a distress call to nearby vessels and the United States Coast Guard. Transmit the following information, in this order:

- 1 “MAYDAY, MAYDAY, MAYDAY.”
- 2 “THIS IS \_\_\_\_\_, CALL SIGN \_\_\_\_\_.” State the name of the vessel in distress 3 times, followed by the call sign or other identification of the vessel, stated 3 times.
- 3 Repeat “MAYDAY” and the name of the vessel.
- 4 “WE ARE LOCATED AT \_\_\_\_\_.” State the position of the vessel in distress, using any information that will help responders to locate you, e.g.:
  - latitude and longitude
  - bearing (state whether you are using true or magnetic north)

- distance to a well-known landmark
  - vessel course, speed or destination
- 5 State the nature of the distress.
  - 6 Specify what kind of assistance you need.
  - 7 State the number of persons on board and the number needing medical attention, if any.
  - 8 Mention any other information that would be helpful to responders, such as type of vessel, vessel length and/or tonnage, hull color, etc.
  - 9 “OVER.”
  - 10 Wait for a response.
  - 11 If you do not receive an immediate response, remain by the radio and repeat the transmission at intervals until you receive a response. Be prepared to follow any instructions given to you.

#### Non-Commercial Call Channel

For non-commercial transmissions, such as fishing reports, rendezvous arrangements, repair scheduling, or berthing information, use **VHF Channel 9**.

### Operating Frequency Requirements

---

A radio designated for shipboard use must comply with Federal Communications Commission Rule Part 80 as follows:

- on ships subject to Part II of Title III of the Communications Act, the radio must be capable of operating on the 156.800 MHz frequency.
- on ships subject to the Safety Convention, the radio must be capable of operating:
  - in the simplex mode on the ship station transmitting frequencies specified in the 156.025 – 157.425 MHz frequency band, and
  - in the semiduplex mode on the two frequency channels specified in the table below.



**Note:**

Simplex channels 3, 21, 23, 61, 64, 81, 82, and 83 cannot be lawfully used by the general public in US waters.

Additional information about operating requirements in the Maritime Services can be obtained from the full text of FCC Rule Part 80 and from the US Coast Guard.

**Table 1: VHF Marine Channel List**

Channel Number	Frequency (MHz)	
	Transmit	Receive

1	156.050	160.650
2	156.100	160.700
*	156.150	160.750
4	156.200	160.800
5	156.250	160.850
6	156.300	–
7	156.350	160.950
8	156.400	–
9	156.450	156.450
10	156.500	156.500
11	156.550	156.550
12	156.600	156.600
13**	156.650	156.650
14	156.700	156.700
15**	156.750	156.750
16	156.800	156.800
17**	156.850	156.850



18	156.900	161.500
19	156.950	161.550
20	157.000	161.600
*	157.050	161.650
22	157.100	161.700
*	157.150	161.750
24	157.200	161.800
25	157.250	161.850
26	157.300	161.900
27	157.350	161.950
28	157.400	162.000
60	156.025	160.625
*	156.075	160.675
62	156.125	160.725
63	156.175	160.775
*	156.225	160.825
65	156.275	160.875

66	156.325	160.925
67**	156.375	156.375
68	156.425	156.425
69	156.475	156.475
71	156.575	156.575
72	156.625	–
73	156.675	156.675
74	156.725	156.725
75	***	***
76	***	***
77**	156.875	–
78	156.925	161.525
79	156.975	161.575
80	157.025	161.625
*	157.075	161.675
*	157.125	161.725
*	157.175	161.775

84	157.225	161.825
85	157.275	161.875
86	157.325	161.925
87	157.375	161.975
88	157.425	162.025

**Note:**

\* Simplex channels 3, 21, 23, 61, 64, 81, 82, and 83 cannot be **lawfully used** by the general public in US waters.

\*\* Low power (1 W) only.

\*\*\* Guard band.

**Note:**

A – in the Receive column indicates that the channel is transmit only.

maritime use when it operates on the distress and safety frequencies specified in RSS-182 Section 7.3.

## Technical Parameters for Interfacing External Data Sources

	RS232	USB	SB9600
<b>Input Voltage (Volts Peak-to-peak)</b>	18V	3.6V	5V
<b>Max Data Rate</b>	28 kb/s	12 Mb/s	9.6 kb/s
<b>Impedance</b>	5000 ohm	90 ohm	120 ohm

## Declaration of Compliance for the Use of Distress and Safety Frequencies

The radio equipment does not employ a modulation other than the internationally adopted modulation for

## Glossary

This glossary is a list of specialized terms used in this manual.



<b>ACK</b>	Acknowledgment of communication.
<b>Active Channel</b>	A channel that has traffic on it.
<b>Analog Signal</b>	An RF signal that has a continuous nature rather than a pulsed or discrete nature.
<b>ARS</b>	Automatic Registration Service
<b>ASTRO 25</b>	Motorola standard for wireless digital trunked communications.
<b>ASTRO Conventional</b>	Motorola standard for wireless digital conventional communications.
<b>Autoscan</b>	A feature that allows the radio to automatically scan the members of a scan list.
<b>Call Alert</b>	Privately page an individual by sending an audible tone.

**Carrier Squelch** Feature that responds to the presence of an RF carrier by opening or unmuting (turning on) a receiver's audio circuit. A squelch circuit silences the radio when no signal is being received so that the user does not have to listen to "noise".

**Central Controller** A software-controlled, computer-driven device that receives and generates data for the trunked radios assigned to it. It monitors and directs the operations of the trunked repeaters.

**Channel** A group of characteristics such as transmit/ receive frequency pairs, radio parameters, and encryption encoding.

**Control Channel** In a trunking system, one of the channels that is used to provide a continuous, two-way/ data communications path between the central controller and all radios on the system.

<b>Conventional</b>	Typically refers to radio-to-radio communications, sometimes through a repeater (see Trunking).		even though the central controller has failed. Each trunked repeater in the system transmits a data word informing every radio that the system has gone into failsoft.
<b>Conventional Scan List</b>	A scan list that includes only conventional channels.		
<b>Digital Private Line (DPL)</b>	A type of coded squelch using data bursts. Similar to PL except a digital code is used instead of a tone.	<b>FCC</b>	Federal Communications Commission.
<b>Digital Signal</b>	An RF signal that has a pulsed, or discrete, nature, rather than a continuous nature.	<b>FM</b>	Frequency Modulation
<b>Dispatcher</b>	An individual who has radio system management duties.	<b>Hang Up</b>	Disconnect.
<b>Dynamic Regrouping</b>	A feature that allows the dispatcher to temporarily reassign selected radios to a single special channel so they can communicate with each other.	<b>Home screen</b>	The first display information after the radio completes its self test.
<b>Failsoft</b>	A feature that allows communications to take place	<b>IV&amp;D</b>	Integrated Voice and Data
		<b>LCD</b>	Liquid crystal display.
		<b>LED</b>	Light-emitting diode.
		<b>Menu Entry</b>	A software-activated feature shown at the bottom of the display – selection of these features is controlled by the  ,  , and  buttons.

<b>Monitor</b>	Check channel activity by pressing the Monitor button. If the channel is clear, you hear static. If the channel is in use, you hear conversation. It also serves as a way to check the volume level of the radio, since the radio “opens the squelch” when the monitor button is pressed.	<b>Non-Tactical/ Revert</b>	The user talks on a preprogrammed emergency channel. The emergency alarm is sent out on this same channel.
<b>Multi-Function Knob</b>	It works as a power on/off button, provides primary and secondary functions like volume change and mode change.	<b>Page</b>	A one-way alert, with audio and/or display messages.
<b>Multi-System Talkgroup Scan List</b>	A scan list that can include both talkgroups (trunked) and channels (conventional).	<b>Personality</b>	A set of unique features specific to a radio.
<b>Network Access Code</b>	Network Access Code (NAC) operates on digital channels to reduce voice channel interference between adjacent systems and sites.	<b>PIN</b>	Personal Identification Number
		<b>Preprogrammed</b>	Refers to a software feature that has been activated by a qualified radio technician.
		<b>Private (Conversation) Call</b>	A feature that lets you have a private conversation with another radio user in the talkgroup.
		<b>Private Line (PL)</b>	A sub-audible tone that is transmitted such that only receivers decoding the tone receives it.

<b>Programmable</b>	Refers to a radio control that can have a radio feature assigned to it.	<b>Squelch</b>	Special electronic circuitry, added to the receiver of a radio, that reduces, or cuts off, unwanted signals before they are heard in the speaker.
<b>PTT</b>	Push-To-Talk. The <b>PTT</b> button engages the transmitter and puts the radio in transmit (send) operation when pressed.	<b>SSI</b>	Synchronous Serial Interface
<b>Radio Frequency (RF)</b>	The part of the general frequency spectrum between the audio and infrared light regions (about 10 kHz to 10,000,000 MHz).	<b>Standby</b>	An operating condition whereby the radio's speaker is muted but still continues to receive data.
<b>Repeater</b>	A conventional radio feature, where you talk through a receive/transmit facility that re-transmits received signals, in order to improve communications range and coverage.	<b>Tactical/ Non-Revert</b>	The user talks on the channel that was selected before the radio entered the emergency state.
<b>Selective Switch</b>	Any digital P25 traffic having the correct Network Access Code and the correct talkgroup.	<b>Talkaround</b>	Bypass a repeater and talk directly to another unit for easy local unit-to-unit communications.
		<b>Talkgroup</b>	An organization or group of radio users who communicate with each other using the same communication path.

<b>Trunking</b>	The automatic sharing of communications paths between a large number of users (see Conventional).
<b>Trunking Priority Monitor Scan List</b>	A scan list that includes talkgroups that are all from the same trunking system.
<b>Zone</b>	A grouping of channels.

## Limited Warranty

### MOTOROLA COMMUNICATION PRODUCTS

#### I. WHAT THIS WARRANTY COVERS AND FOR HOW LONG:

MOTOROLA SOLUTIONS, INC. (“MOTOROLA”) warrants the MOTOROLA manufactured Communication Products listed below (“Product”) against defects in material and workmanship under normal use and service for a period of time from the date of purchase as scheduled below:

ASTRO APX 2000 Portable Units	One (1) Year
Product Accessories	One (1) Year

For LACR region:

ASTRO APX 2000 Portable Units	Three (3) Years
Product Accessories	One (1) Year

MOTOROLA, at its option, will at no charge either repair the Product (with new or reconditioned parts), replace it (with a new or reconditioned Product), or refund the purchase price of the Product during the warranty period provided it is returned in accordance with the terms of this warranty. Replaced parts or boards are warranted for the balance of the original applicable warranty period. All replaced parts of Product shall become the property of MOTOROLA.

This express limited warranty is extended by MOTOROLA to the original end user purchaser only and is not assignable or transferable to any other party. This is the complete warranty for the Product manufactured by MOTOROLA. MOTOROLA assumes no obligations or liability for additions or modifications to this warranty unless made in writing and signed by an officer of MOTOROLA.

Unless made in a separate agreement between MOTOROLA and the original end user purchaser, MOTOROLA does not warrant the installation, maintenance or service of the Product.

MOTOROLA cannot be responsible in any way for any ancillary equipment not furnished by MOTOROLA which is attached to or used in connection with the Product, or for operation of the Product with any



ancillary equipment, and all such equipment is expressly excluded from this warranty. Because each system which may use the Product is unique, MOTOROLA disclaims liability for range, coverage, or operation of the system as a whole under this warranty.

MOTOROLA offers the following optional extended service contracts.

### **SERVICE FROM THE START (SfS) COMPREHENSIVE**

Provides for extended hardware repair coverage INCLUDING CHEMICAL, LIQUID, FIRE, AND OTHER PHYSICAL DAMAGE. Comprehensive coverage is available in conjunction with MOTOROLA'S standard Commercial Warranty and starts from the FIRST DAY the radio is put into use. Service performed under this plan consists of repair or replacement of the covered equipment as set forth in the terms and conditions. Repairs will be made only at the designated MOTOROLA repair depot. Local services are not included. MOTOROLA will pay the inbound shipping charges only with use of the MOTOROLA designated delivery service. MOTOROLA will pay for outbound shipping via MOTOROLA'S normal shipping methods.

### **SERVICE FROM THE START (SfS) LITE**

Provides extended hardware normal wear and tear repair coverage beginning AFTER MOTOROLA'S standard Commercial Warranty period expires. Service performed under this plan consists of repair of the covered equipment as set forth in the terms and conditions. Repairs will be made only at the designated MOTOROLA repair depot. Local services are not included. MOTOROLA will pay for outbound shipping via MOTOROLA'S normal shipping methods.

## **II. GENERAL PROVISIONS:**

---

This warranty sets forth the full extent of MOTOROLA'S responsibilities regarding the Product. Repair, replacement or refund of the purchase price, at MOTOROLA's option, is the exclusive remedy. THIS WARRANTY IS GIVEN IN LIEU OF ALL OTHER EXPRESS WARRANTIES. IMPLIED WARRANTIES, INCLUDING WITHOUT LIMITATION, IMPLIED WARRANTIES OF MERCHANTABILITY AND FITNESS FOR A PARTICULAR PURPOSE, ARE LIMITED TO THE DURATION OF THIS LIMITED WARRANTY. IN NO EVENT SHALL MOTOROLA BE LIABLE FOR DAMAGES IN EXCESS OF THE PURCHASE PRICE OF THE

PRODUCT, FOR ANY LOSS OF USE, LOSS OF TIME, INCONVENIENCE, COMMERCIAL LOSS, LOST PROFITS OR SAVINGS OR OTHER INCIDENTAL, SPECIAL OR CONSEQUENTIAL DAMAGES ARISING OUT OF THE USE OR INABILITY TO USE SUCH PRODUCT, TO THE FULL EXTENT SUCH MAY BE DISCLAIMED BY LAW.

prepaid, to an authorized warranty service location. Warranty service will be provided by MOTOROLA through one of its authorized warranty service locations. If you first contact the company which sold you the Product (e.g., dealer or communication service provider), it can facilitate your obtaining warranty service. You can also call MOTOROLA at 1-800-927-2744 US/Canada.

### **III. STATE LAW RIGHTS:**

---

SOME STATES DO NOT ALLOW THE EXCLUSION OR LIMITATION OF INCIDENTAL OR CONSEQUENTIAL DAMAGES OR LIMITATION ON HOW LONG AN IMPLIED WARRANTY LASTS, SO THE ABOVE LIMITATION OR EXCLUSIONS MAY NOT APPLY.

This warranty gives specific legal rights, and there may be other rights which may vary from state to state.

### **IV. HOW TO GET WARRANTY SERVICE:**

---

You must provide proof of purchase (bearing the date of purchase and Product item serial number) in order to receive warranty service and, also, deliver or send the Product item, transportation and insurance

### **V. WHAT THIS WARRANTY DOES NOT COVER:**

---

- 1 Defects or damage resulting from use of the Product in other than its normal and customary manner.
- 2 Defects or damage from misuse, accident, water, or neglect.
- 3 Defects or damage from improper testing, operation, maintenance, installation, alteration, modification, or adjustment.
- 4 Breakage or damage to antennas unless caused directly by defects in material workmanship.
- 5 A Product subjected to unauthorized Product modifications, disassembles or repairs (including, without limitation, the addition to the Product of non-MOTOROLA supplied equipment) which

adversely affect performance of the Product or interfere with MOTOROLA's normal warranty inspection and testing of the Product to verify any warranty claim.

- 6 Product which has had the serial number removed or made illegible.
- 7 Rechargeable batteries if:
  - any of the seals on the battery enclosure of cells are broken or show evidence of tampering.
  - the damage or defect is caused by charging or using the battery in equipment or service other than the Product for which it is specified.
- 8 Freight costs to the repair depot.
- 9 A Product which, due to illegal or unauthorized alteration of the software/firmware in the Product, does not function in accordance with MOTOROLA's published specifications or the FCC certification labeling in effect for the Product at the time the Product was initially distributed from MOTOROLA.
- 10 Scratches or other cosmetic damage to Product surfaces that does not affect the operation of the Product.
- 11 Normal and customary wear and tear.

## **VI. PATENT AND SOFTWARE PROVISIONS:**

MOTOROLA will defend, at its own expense, any suit brought against the end user purchaser to the extent that it is based on a claim that the Product or parts infringe a United States patent, and MOTOROLA will pay those costs and damages finally awarded against the end user purchaser in any such suit which are attributable to any such claim, but such defense and payments are conditioned on the following:

- 1 that MOTOROLA will be notified promptly in writing by such purchaser of any notice of such claim,
- 2 that MOTOROLA will have sole control of the defense of such suit and all negotiations for its settlement or compromise, and
- 3 should the Product or parts become, or in MOTOROLA's opinion be likely to become, the subject of a claim of infringement of a United States patent, that such purchaser will permit MOTOROLA, at its option and expense, either to procure for such purchaser the right to continue using the Product or parts or to replace or modify the same so that it becomes non-infringing or to grant such purchaser a credit for the Product or parts as depreciated and accept its return. The

depreciation will be an equal amount per year over the lifetime of the Product or parts as established by MOTOROLA.

MOTOROLA will have no liability with respect to any claim of patent infringement which is based upon the combination of the Product or parts furnished hereunder with software, apparatus or devices not furnished by MOTOROLA, nor will MOTOROLA have any liability for the use of ancillary equipment or software not furnished by MOTOROLA which is attached to or used in connection with the Product. The foregoing states the entire liability of MOTOROLA with respect to infringement of patents by the Product or any parts thereof.

Laws in the United States and other countries preserve for MOTOROLA certain exclusive rights for copyrighted MOTOROLA software such as the exclusive rights to reproduce in copies and distribute copies of such MOTOROLA software. MOTOROLA software may be used in only the Product in which the software was originally embodied and such software in such Product may not be replaced, copied, distributed, modified in any way, or used to produce any derivative thereof. No other use including, without limitation, alteration, modification, reproduction, distribution, or reverse engineering of

such MOTOROLA software or exercise of rights in such MOTOROLA software is permitted. No license is granted by implication, estoppel or otherwise under MOTOROLA patent rights or copyrights.

## **VII. GOVERNING LAW:**

---

This Warranty is governed by the laws of the State of Illinois, U.S.A.

## **VIII. For Australia Only**

---

This warranty is given by Motorola Solutions Australia Pty Limited (ABN 16 004 742 312) of Tally Ho Business Park, 10 Wesley Court. Burwood East, Victoria.

Our goods come with guarantees that cannot be excluded under the Australia Consumer Law. You are entitled to a replacement or refund for a major failure and compensation for any other reasonably foreseeable loss or damage. You are also entitled to have the goods repaired or replaced if the goods fail to be of acceptable quality and the failure does not amount to a major failure.

Motorola Solutions Australia's limited warranty above is in addition to any rights and remedies you may

have under the Australian Consumer Law. If you have any queries, please call Motorola Solutions Australia at 1800 457 439. You may also visit our website: [http://www.motorolasolutions.com/XA-EN/Pages/Contact\\_Us](http://www.motorolasolutions.com/XA-EN/Pages/Contact_Us) for the most updated warranty terms.



## Notes

Notes





**MOTOROLA**

Motorola Solutions, Inc.  
1303 East Algonquin Road  
Schaumburg, Illinois 60196 U.S.A.

MOTOROLA, MOTO, MOTOROLA SOLUTIONS and the Stylized M logo are trademarks or registered trademarks of Motorola Trademark Holdings, LLC and are used under license.

All other trademarks are the property of their respective owners.

© 2012 and 2015 Motorola Solutions, Inc. All rights reserved.

June 2015



**68012005017-DB**

