



ASTRO® APX™ 8000XE Series Digital Portable Radios Quick Reference Card

RF Energy Exposure and Product Safety Guide for Portable Two-Way Radios

ATTENTION!

This radio is restricted to Occupational use only. Before using the radio, read the RF Energy Exposure and Product Safety Guide for Portable Two-Way Radios which contains important operating instructions for safe usage and RF energy awareness and control for Compliance with applicable standards and Regulations.

Radio Controls

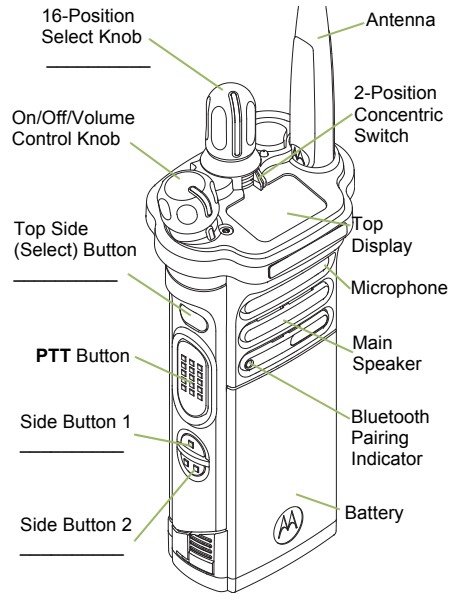
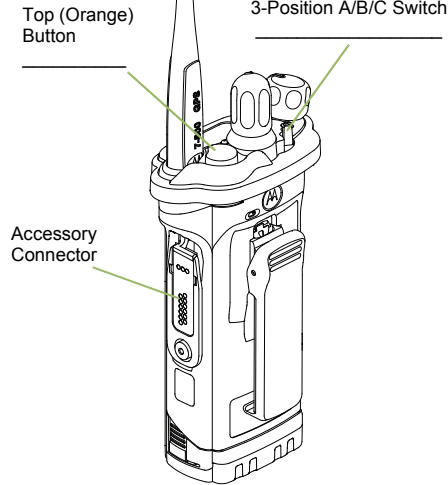

Radio On/Off

- On – On/Off/Volume knob clockwise.
- Off – On/Off/Volume knob counterclockwise.

Zones and Channels

- Zone – Toggle the Zone switch or use the radio menu to the desired zone.
- Channel – Turn the Channel knob or use the radio menu to the desired channel.

Receiving and Transmitting

- 1 Select zone/channel.
- 2 Listen for a transmission.
OR
Press and hold **Volume Set** button.
OR
Press **Monitor** button and listen for activity.
- 3 Adjust volume, if necessary.
- 4 Press the **PTT** button to transmit; release to receive.

Sending an Emergency Alarm

- 1 Press and hold the **Emergency** button*.
- 2 The display shows **EMERGENCY** and the current zone/channel. A short, medium-pitched tone sounds, and the LED blinks red momentarily.
- 3 When acknowledgment is received, you hear four beeps; alarm ends; and radio exits emergency.

***Default timer of Emergency button press to activate Emergency is 50 milliseconds. This timer is programmable, see Emergency Operation in the user guide for details.**

To exit emergency at any time, press and hold the **Emergency** button.



PMLN7485A



English

■ Sending an Emergency Call

- 1 Press the **Emergency** button.
- 2 Press and hold the **PTT** button. Speak clearly into the microphone.
- 3 Release the **PTT** button to end call.
- 4 Press and hold **Emergency** button to exit emergency.











*To exit emergency at any time, press and hold the **Emergency** button.*













■ Sending a Silent Emergency Call

- 1 Press the **Emergency** button.
- 2 The display does not change; the LED does not light up, and there is no tone.
- 3 Silent emergency continues until you:
Press and hold the **Emergency** button to exit emergency state.
OR
Press and release the **PTT** button to exit the Silent Emergency Alarm mode and enter regular dispatch or Emergency Call mode.

*To exit emergency at any time, press and hold the **Emergency** button.*

■ Display Status Icons

	Blinks when the battery is low.
	The more stripes, the stronger the signal strength for the current site (trunking only).
	Direct radio to radio communication or connected through a repeater. On = Direct Off = Repeater
	This channel is being monitored.
	L = Radio is set at Low power. H = Radio is set at High power.
	Scanning a scan list.
	Blinking dot = Detects activity on the Priority-One Channel during scan. Steady dot = Detects activity on the Priority-Two Channel during scan.
	The vote scan feature is enabled.
	On = Secure operation. Off = Clear operation. Blinking = Receiving an encrypted voice call.
	On steady = View mode Blinking = Program mode

 A or  B or  C	Basic Zone Bank 1 A = Radio is in Zone 1. B = Radio is in Zone 2. C = Radio is in Zone 3.
 D or  E or  F	Basic Zone Bank 2 D = Radio is in Zone 4. E = Radio is in Zone 5. F = Radio is in Zone 6.
 A , B ,  C  X or  Y	Enhanced Zone Bank A = Contains Zone 1, Zone 2 and Zone 3, B = Contains Zone 4, Zone 5 and Zone 6, C = Contains Zone 7, Zone 8 and Zone 9, . . . X = Contains Zone 70, Zone 71 and Zone 72, Y = Contains Zone 73, Zone 74 and Zone 75.
	Bluetooth is ready.
	Bluetooth is connected to the device.