

Vertex Standard

VX-920E SERIES

OPERATING MANUAL

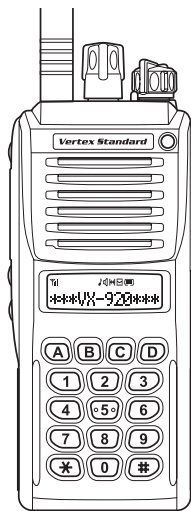

16-KEY VERSION

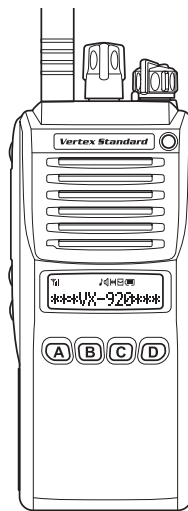

4-KEY VERSION

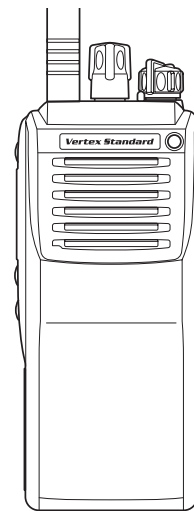

NON-LCD VERSION

Vertex Standard LMR, Inc.

CONTENTS

Warning! RF Exposure Requirements	2	Operation	12
Controls & Connectors (16-Key Version)	4	Preliminary Steps.....	12
Controls & Connectors (4-Key Version)	5	Operation Quick Start.....	12
Controls & Connectors (Non-LCD Version)	6	Automatic Time-Out Timer.....	14
LCD Icons & Indicators (16- & 4-Key Versions)	7	Advanced Operation	15
Before You Begin	8	Programmable Key and Toggle Switch Functions.....	15
Battery Pack Installation and Removal.....	8	Description of Operating Functions.....	18
Low Battery Indication.....	8	ARTS™ (Auto Range Transpond System)	26
Battery Charging (VAC-UNI: CD-58/PA-55).....	9	DTMF Paging System	26
Battery Charging (VAC-920: CD-31/PA-42).....	10	LOCK	26
		User Set Mode	27
		Optional Accessories	28

CONGRATULATIONS!

You now have at your fingertips a valuable communications tool—a Vertex Standard two-way radio! Rugged, reliable and easy to use, your Vertex Standard radio will keep you in constant touch with your colleagues for years to come, with negligible maintenance down-time. Please take a few minutes to read this manual carefully. The information presented here will allow you to derive maximum performance from your radio, in case questions arise later on.

We're glad you joined the Vertex Standard team. Call on us anytime, because communications is our business. Let us help you get your message across.

Important Note

- There are no owner-serviceable parts inside the radio. All service jobs must be referred to an authorized Vertex Standard Service Representative. Consult your Authorized Vertex Standard Dealer for installation of optional accessories.
- In order to maintain the specified water integrity performance, periodic maintenance is recommended.
- Should the radio sustain a severe shock (e.g. if it is dropped), the water integrity may be compromised, requiring service. Should this occur, contact your Authorized Vertex Standard Dealer.

WARNING! RF EXPOSURE REQUIREMENTS

This Radio has been tested and complies with the 1999/519/EC RF exposure limits. In addition, it complies with the following Standards and Guidelines:

- ❑ ANSI/IEEE C95.1-1992, IEEE Standard for Safety Levels with Respect to Human Exposure to Radio Frequency Electromagnetic Fields, 3 kHz to 300 GHz.
- ❑ ANSI/IEEE C95.3-1992, IEEE Recommended Practice for the Measurement of Potentially Hazardous Electromagnetic Fields - RF and Microwave.



WARNING:

This radio generates RF electromagnetic energy during transmit mode. This radio is designed for and classified as Occupational Use Only, meaning it must be used only during the course of employment by individuals aware of the hazards, and the ways to minimize such hazards. This radio is not intended for use by the General Population in an uncontrolled environment.

- **This radio is NOT approved for use by the general population in an uncontrolled exposure environment. This radio is restricted to occupational use, work related operations only where the radio operator must have the knowledge to control his or her RF exposure conditions.**
- **When transmitting, hold the radio in a vertical position with its microphone 5 cm away from your mouth and keep the antenna at least 5 cm away from your head and body.**
- **The radio must be used with a maximum operating duty cycle not exceeding 50%, in typical Push-to-Talk configurations.**
DO NOT transmit for more than 50% of total radio use time (50% duty cycle). Transmitting more than 50% of the time can cause FCC RF exposure compliance requirements to be exceeded.
The radio is transmitting when the red LED on the front panel of the radio is illuminated. You can cause the radio to transmit by pressing the P-T-T button.
- **SAR compliance for body-worn use was only demonstrated for the specific belt-clip Part Number (CLIP-920). Other body-worn accessories or configurations may NOT comply with the FCC RF exposure requirements and should be avoided.**

WARNING! FCC RF EXPOSURE REQUIREMENTS

- **DO NOT** transmit when the radio is used in Body Worn configuration with the following accessory: belt-clip.
It must be used **ONLY** for (1) there is 4 cm distance from the body during transmitting, (2) monitoring purposes, using the speaker only and (3) for carrying purposes.
- Always use Vertex Standard authorized accessories.
- The information listed above provides the user with the information needed to make him or her aware of RF exposure, and what to do to assure that this radio operates with the FCC RF exposure limits of this radio.
- **Electromagnetic Interference/Compatibility**
During transmissions, this radio generates RF energy that can possibly cause interference with other devices or systems. To avoid such interference, turn off the radio in areas where signs are posted to do so. Do not operate the transmitter in areas that are sensitive to electromagnetic radiation such as hospitals, health care facilities, aircraft, and blasting sites.

CONTROL & CONNECTORS (16-KEY VERSION)

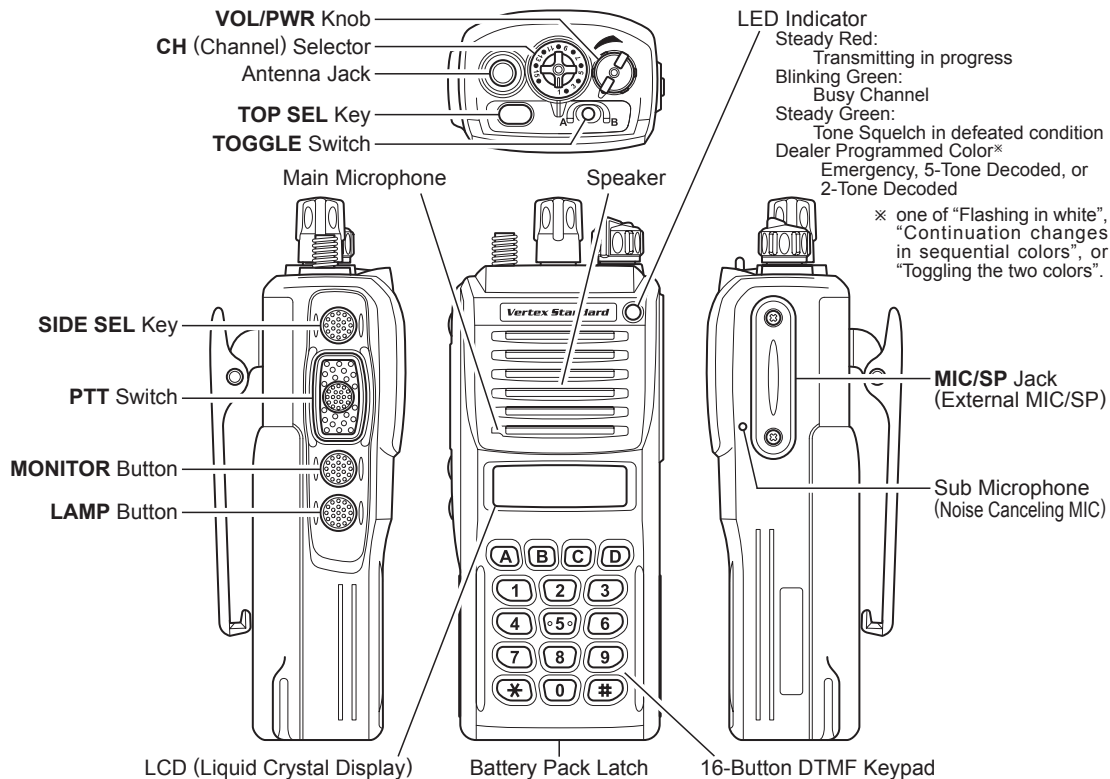

CONTROL & CONNECTORS (4-KEY VERSION)

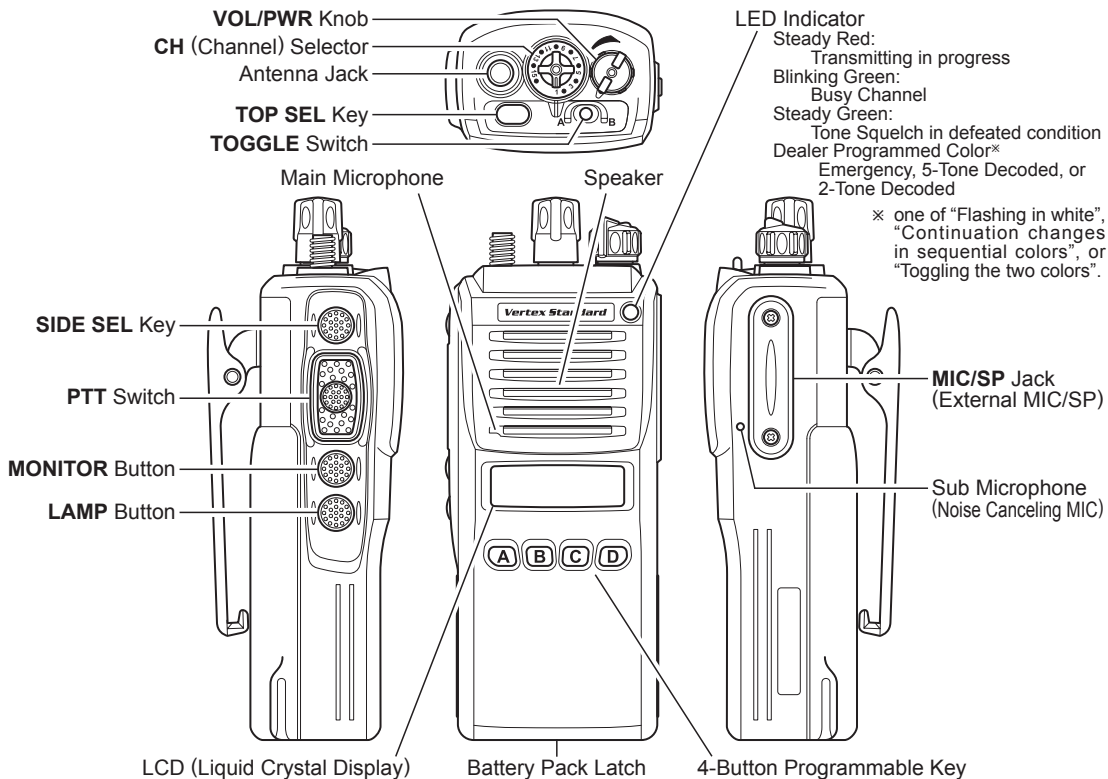

CONTROL & CONNECTORS (NON-LCD VERSION)

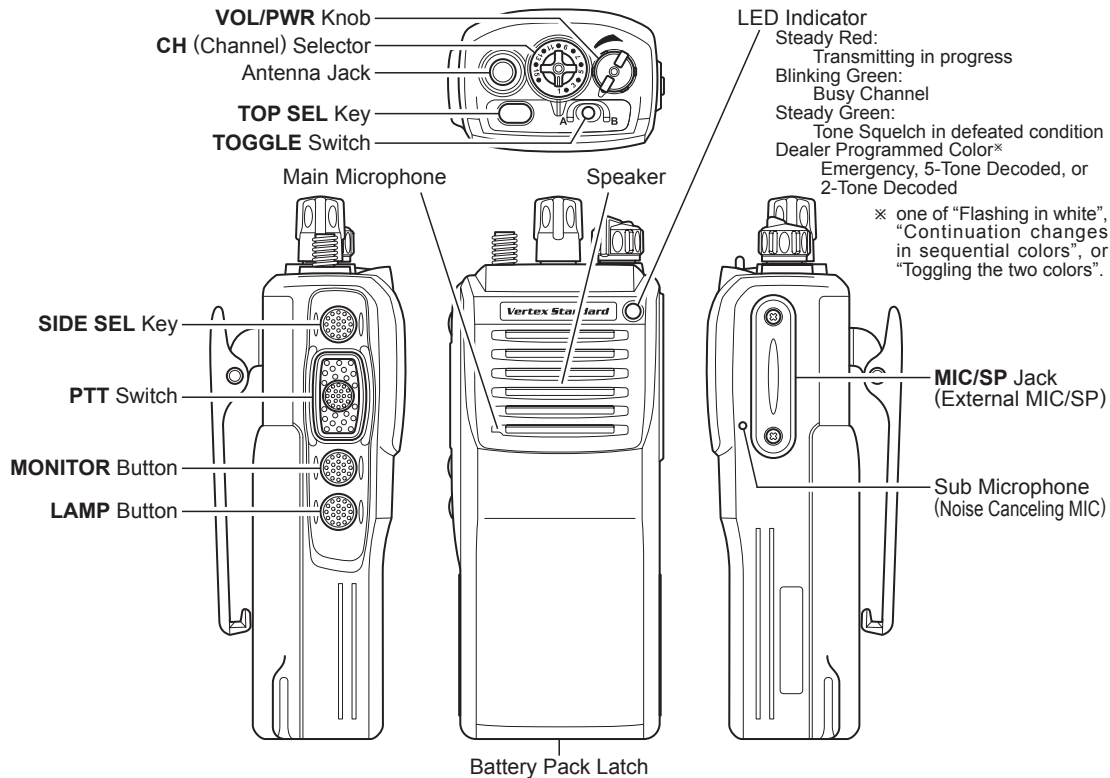

LCD ICONS & INDICATORS (16-KEY & 4-KEY VERSIONS)

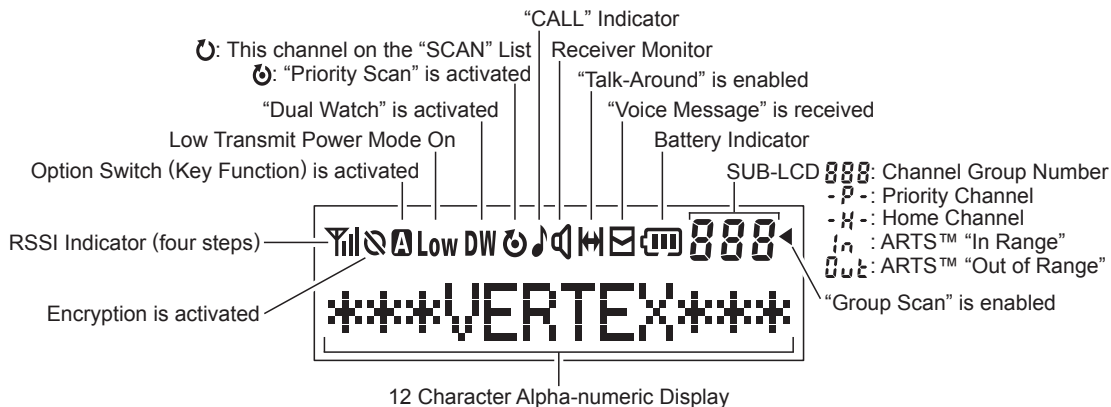

BEFORE YOU BEGIN

Battery Pack Installation and Removal

- ❑ To install the battery, hold the transceiver with your left hand, so your palm is over the speaker and your thumb is on the top of the belt clip. Carefully mate the battery's four insertion slots with their corresponding alignment tabs on the transceiver case, while tilting the Belt Clip outward. Proper alignment occurs with the battery pack offset about 1.5 cm from the top edge of the battery compartment.
- ❑ Guide the pack on to the tabs with a slight inward pressure, then slide the battery pack upward, until it locks in place with a "Click".

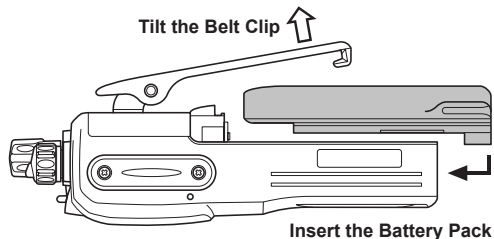

- ❑ To remove the battery, turn the radio off and remove any protective cases. Slide the Battery Pack Latch on the bottom of the radio toward the front panel while sliding the battery down about 1.5 cm. Then lift the battery out from the radio while

unfolding the Belt Clip.



Do not attempt to open any of the rechargeable Lithium-Ion packs, as they could explode if accidentally short-circuited.

Low Battery Indication

As the battery discharges during use, the voltage gradually becomes lower. When the battery voltage becomes too low, substitute a freshly charged battery and recharge the depleted pack. The LED indicator on the top of the radio will blink red when the battery voltage is low.



Caution

Danger of explosion if battery is replaced with an incorrect battery. Replace only with the same or equivalent type.

Note

The **FBA-34** was designed as a backup battery pack, and it can be used to power the transceiver if you are in an area that does not require the use of an intrinsically safe radio.

BEFORE YOU BEGIN

Battery Charging (VAC-UNI: CD-58/PA-55) for the FNB-V127LI-UNI/-V128LI-UNI/-V129LI-UNI

- ❑ Install the Spacer Plate to the nest of the optional **CD-58** Desktop Charger, if the Battery Spacer is not installed.
- ❑ Insert the DC plug from the optional **PA-55** AC Adapter into the DC jack on the rear panel of the optional **CD-58** Desktop Charger, and then connect the **PA-55** AC Adapter to the AC line outlet.
- ❑ Insert the battery pack into the **CD-58** Desktop Charger while aligning the slots of the battery pack with the guides in the nest of the **CD-58**; refer to the following illustration for details on proper positioning of the battery pack. If charging with the transceiver attached, turn the transceiver off. The antenna jack should be at the left side when viewing the charger from the front.
- ❑ If the battery pack is inserted correctly, the LED indicator will glow red. A fully-discharged battery pack will charge completely in 1.5 - 3.0 hours (depending on the battery pack being charged).
- ❑ When charging is completed, the LED indicator will change to green.
- ❑ Disconnect the battery pack from the **CD-58** Desktop Charger and unplug the **PA-55** AC Adapter from the AC line outlet.

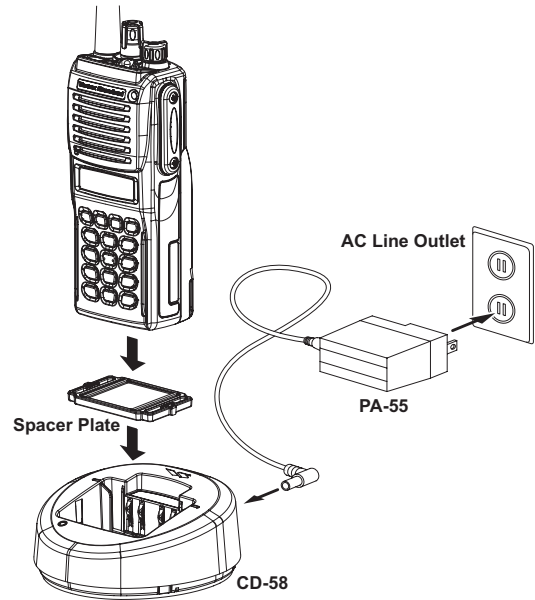

BEFORE YOU BEGIN



- 1) The VAC-UNI (CD-58/PA-55) charges only the Vertex Standard FNB-V127LI-UNI, FNB-V128LI-UNI and FNB-V129LI-UNI Lithium-Ion Battery Pack.*
- 2) Use only the Vertex Standard PA-55 AC Adapter.*
- 3) To reduce the risk of explosion, recharge the batteries outside of hazardous locations.*
- 4) Perform the battery charging where the ambient temperature range +5 °C to +40 °C. Charge out of this range could cause damage to the battery pack.*
- 5) Battery Pack shall not be exposed to excessive heat such as sunshine, fire, or the like.*
- 6) Risk of explosion if battery is replaced by an incorrect type. Dispose of used batteries according to the instructions.*
- 7) For further details and cautions of the charging, refer to the Operating Manual of the CD-58 Desktop Charger.*

BEFORE YOU BEGIN

Battery Charging (VAC-920: CD-31/PA-42) for the FNB-V86LIA/-V87LIA/-V92LI

- ❑ Insert the DC plug from the **PA-42** AC Adapter into the DC jack on the bottom side of the **CD-31** Desktop Rapid Charger, then plug the **PA-42** AC Adapter into the AC line outlet.
- ❑ Insert the battery pack into the **CD-31** Desktop Rapid Charger while aligning the slots of the battery pack with the guides in the nest of the **CD-31**; refer to the illustration at the right for details on proper positioning of the pack. If charging with the transceiver attached, turn the transceiver off, and the antenna jack should be at the left side when viewing the charger from the front.
- ❑ If the battery pack is inserted correctly, the LED indicator will glow red. A fully-discharged pack

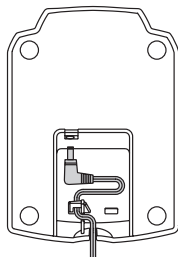

Insert the DC plug from the **PA-42** AC Adapter into the DC jack of the **CD-31** Desktop Rapid Charger.

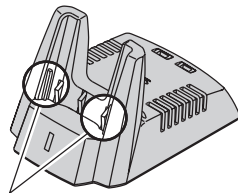

Align the slots of the battery pack with the guides in the nest of the **CD-31** Desktop Rapid Charger.

will be charged completely in 1.5 - 3.0 hours (depending on the battery pack being charged).

- ❑ The LED indicator will blink red/green alternately when charging is nearing completion.
- ❑ When charging is completed, the LED indicator will change to green. Even if the charging is completed, the LED indicator will sometimes change to red for trickle charging.
- ❑ Disconnect the pack from the **CD-31** Desktop Rapid Charger, and unplug the **PA-42** AC Adapter from the AC line outlet.



- 1) *The VAC-920 (CD-31/PA-42) charges only the Vertex Standard FNB-V86LIA, FNB-V87LIA, and FNB-V92LI Lithium-Ion Battery Pack.*
- 2) *Use only the Vertex Standard PA-42 AC Adapter.*
- 3) *To reduce the risk of explosion, recharge the batteries outside of hazardous locations.*
- 4) *Perform the battery charging where the ambient temperature range +5 °C to +40 °C. Charge out of this range could cause damage to the battery pack.*
- 5) *Battery Pack shall not be exposed to excessive heat such as sunshine, fire, or the like.*
- 6) *Risk of explosion if battery is replaced by an incorrect type. Dispose of used batteries according to the instructions.*

OPERATION

Preliminary Steps

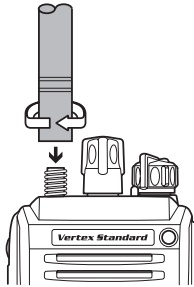

- ❑ Install a charged battery pack onto the transceiver, as described previously.
- ❑ Screw the supplied antenna onto the Antenna jack. Never attempt to operate this transceiver without an antenna connected.
- ❑ If you have a Speaker/Microphone, we recommend that it not be connected until you are familiar with the basic operation of the **VX-920E**.



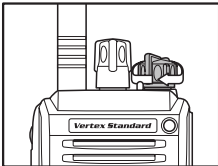
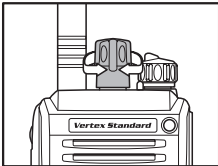

Operation Quick Start

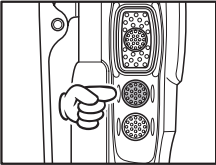
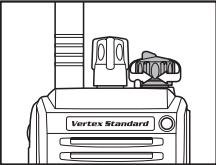
- ❑ Turn the top panel's **VOL/PWR** knob clockwise to turn the radio on.
- 
- ❑ Turn the top panel's **CH** selector knob to choose the desired operating channel. On the 16-key and 4-key versions, a channel name will appear on the LCD.
- 
- ❑ If you want to select the operating channel from a different Memory Channel Group, press the Programmable key (assigned to the Memory Group Up or Down function) to select the Memory Channel Group you want before selecting the operating channel. A Group name will appear on the LCD whenever the Programmable key is pressed. **Note:** Some models are programmed so that the operating channels are selected by the Programmable key and the memory channel group is selected by the **CH** selector knob. For further details, contact your Vertex Standard dealer.

OPERATION

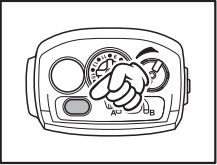
- ❑ Rotate the **VOL/PWR** knob to set the volume level. If no signal is present, press and hold in the **MONITOR** button (under the **PTT** switch) more than 2 seconds; background noise will now be heard, and you may use this to set the **VOL/PWR** knob for the desired audio level. Press and hold the **MONITOR** button more than 2 seconds (or press the **MONITOR** button *twice*) to quiet the noise and resume normal (quiet) monitoring.
- ❑ To transmit, monitor the channel and make sure it is clear. Press and hold the **PTT** switch. Speak into the microphone area of the front panel (at the lower right corner of the speaker grille) in a normal voice level. To return to the Receive mode, release the **PTT** switch.

- ❑ Press the (Orange) **TOP SEL** key or **SIDE SEL** key (above the **PTT** switch) to activate one of the pre programmed functions which may have been enabled at the time of programming by the dealer. See the next section for details regarding the available features.

- ❑ Switch the top panel's **TOGGLE** switch to the **[A]**, **[B]**, or **[Center]** position to activate one of the pre-programmed functions which may have been enabled at the time of programming by the dealer. When this switch is in the **[A]**(left), **[B]**(right), or **[Center]** position, the feature programmed (by your dealer) to that switch position will be activated. See the next section for details regarding the available features.

OPERATION

- ❑ If a Speaker/Microphone is available, remove the plastic cap and its two mounting screws from the right side of the transceiver, then align the connector of the Speaker/Microphone on the transceiver body; secure the connector pin using the screws supplied with the Speaker/Microphone. Hold the speaker grille up next to your ear while receiving. To transmit, press the **PTT** switch on the Speaker/Microphone, just as you would on the main transceiver's body, and speak into the microphone on a normal voice level.

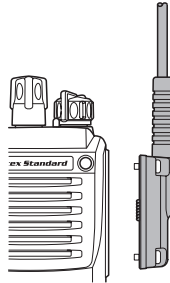

 **Note 1): Save the original plastic cap and its mounting screws. They should be reinstalled when not using the Speaker/Microphone.**
2) When you press the PTT switch on the Speaker/Microphone, it disables the internal microphone, and vice versa.

Do not remove/install the Speaker/Microphone in a hazardous location.

- ❑ If the Busy Channel Lockout feature has been programmed on a channel, the radio will not transmit when a carrier is present. Instead, the radio will generate short beep three times and indicate

“***CH Busy***” on the display (16-key and 4-key versions). Release the **PTT** switch and wait for the channel to be clear of activity.

- ❑ If CTCSS or Digital Coded Squelch (DCS) Lockout has been programmed on a channel, the radio can transmit only when there is no carrier being received or when the carrier being received includes the correct CTCSS tone or DCS code.

Automatic Time-Out Timer

If the selected channel has been programmed for automatic time-out, you must limit the length of each transmission. While transmitting, a beep will sound 10 seconds before time-out. Another beep will sound just before the deadline; the “**TX**” indicator will disappear and transmission will cease soon thereafter. To resume transmitting, you must release the **PTT** switch and wait for the “Penalty timer” to expire.

ADVANCED OPERATION

Programmable Key and Toggle Switch Functions

All versions of the **VX-920E** include the **TOP SEL**, **SIDE SEL**, **MONITOR**, **LAMP** keys and **TOGGLE** switch. The 16-key and 4-key versions include the [A], [B], [C], and [D] function keys. Furthermore, the 16-key version includes the [*] and [#] function keys.

The Programmable key and Toggle switch functions can be customized, via programming by your Vertex Standard dealer, to meet your communications/network requirements. Some features may require the purchase and installation of optional internal accessories. The possible Programmable key and Toggle switch programming features are illustrated at the right, and their functions are explained on page 18. For further details, contact your Vertex Standard dealer.

For future reference, check the box next to each function that has been assigned to the Programmable key and Toggle switch on your particular radio, and keep it handy.

FUNCTION	TOGGLE SWITCH (POSITION)		
	A	Center	B
None			
Scan			
Dual Watch			
Low Power			
Talk Around			
TX Save Disable			
Encryption*			
Lock			
Follow-Me Scan			
Audio PC (PIC)			
Clear Voice			
Group Recall Shortcut	<input type="checkbox"/> Group 1 <input type="checkbox"/> Group 2 <input type="checkbox"/> Group 3	<input type="checkbox"/> Group 1 <input type="checkbox"/> Group 2 <input type="checkbox"/> Group 3	<input type="checkbox"/> Group 1 <input type="checkbox"/> Group 2 <input type="checkbox"/> Group 3

※: Requires **FVP-35** or **FVP-36** Encryption Unit.

ADVANCED OPERATION

FUNCTION	PROGRAMMABLE KEY									
	TOP SEL	SIDE SEL	MONITOR	LAMP	16-KEY & 4-KEY VERSIONS				16-KEY VERSION	
					[A]	[B]	[C]	[D]	[*]	[#]
None										
Monitor										
Lamp ^{※1}										
Scan										
Dual Watch										
Low Power										
Talk Around										
TX Save Disable										
Encryption ^{※2}										
Lock										
Follow-Me Scan										
Audio PC (PIC)										
Follow-Me Dual Watch										
Group Up ^{※1}										
Group Down ^{※1}										
Channel Up ^{※1}										
Channel Down ^{※1}										
Set										
Call/Reset										
Call 1										
Call 2										
Call 3										
Call 4										
Call 5										
Code Up ^{※1}										
Code Down ^{※1}										
Code Set ^{※1}										
Speed Dial ^{※3}										
Option SW 1										
Option SW 2										
Emergency										
Home ^{※1}										

※1: This function can not be selected on the Non-LCD version.

※2: Requires **FVP-35** or **FVP-36** Encryption Unit.

※3: This function is only selected on the 16-key version.

ADVANCED OPERATION

FUNCTION	PROGRAMMABLE KEY									
	TOP SEL	SIDE SEL	MONITOR	LAMP	16-KEY & 4-KEY VERSIONS				16-KEY VERSION	
					[A]	[B]	[C]	[D]	[*]	[#]
Selectable Tone ^{×1}										
Direct Channel #1 ^{×1}										
Direct Channel #2 ^{×1}										
Direct Channel #3 ^{×1}										
Direct Channel #4 ^{×1}										
REC/PLAY ^{×3}										
REC ^{×3}										
PLAY ^{×3}										
SQL										
AF Min Volume										
Status Set ^{×1}										
Status Up ^{×1}										
Status Down ^{×1}										
Status Check										
Lone Worker										
DTMF Code Set ^{×2}										
TA Scan										

×1: This function can not be selected on the Non-LCD version.

×2: This function is only selected on the 16-key version.

×3: Requires **DVS-5** Voice Storage Unit.

ADVANCED OPERATION

Description of Operating Functions

MONITOR

Press the assigned programmable key to cancel CTCSS- and DCS-controlled squelch; the **BUSY/TX** indicator will glow green. Press and hold this button for 1.5 seconds to hear background noise (unmute the audio); the **BUSY/TX** indicator will blink green.

LAMP (16-KEY & 4-KEY VERSION ONLY)

Press the assigned programmable key to illuminate the LCD for five seconds.

SCAN

The Scanning feature is used to monitor multiple signals programmed into the transceiver. While scanning, the transceiver will check each channel for the presence of a signal, and will stop on a channel if a signal is present.

To activate scanning:

- Press the assigned programmable key, or set the **TOGGLE** switch to the assigned position to activate scanning.
- The scanner will search the channels of each channel, looking for active ones; it will pause each time it finds a channel on which someone is speaking.
- Press the assigned programmable key again, or set the **TOGGLE** switch to a different position to disable scanning. Operation will revert to the programmed revert channel.

Note: Your dealer may have programmed your radio to stay on one of the following channels if you press the **PTT** switch during scanning pause:

- Current channel (“Talk Back”)
- “Last Busy” channel
- “Priority” channel
- “Home” channel
- “Scan Start” channel

ADVANCED OPERATION

DUAL WATCH

The Dual Watch feature is similar to the SCAN feature, except that only two channels are monitored:

- The current operating channel; and
- The Priority channel.

To activate Dual Watch:

- Press the assigned programmable key, or set the **TOGGLE** switch to the assigned position.
- The scanner will search the two channels; it will pause each time it finds a channel on which someone is speaking.

To stop Dual Watch:

- Press the assigned programmable key, or set the **TOGGLE** switch to a different position.
- Operation will revert to the “Dual Watch Start” channel.

LOW POWER

Press the assigned programmable key, or set the **TOGGLE** switch to the assigned position to set the radio’s transmitter to the “Low Power” mode, thus extending battery life. Press the key again, or set the **TOGGLE** switch to a different position to return to “Normal” transmit power when in difficult terrain.

In the 16-key and 4-key versions, the “**Low**” icon will be indicated on the display when the radio’s transmitter is set to “Low Power” mode.

TALK AROUND (TA)

Press the assigned programmable key, or set the **TOGGLE** switch to the assigned position to activate the Talk Around feature when you are operating on duplex channel systems (separate receive and transmit frequencies, utilizing a “repeater” station). The Talk Around feature allows you to bypass the repeater station and talk directly to a station that is nearby. This feature has no effect when you are operating on “simplex” channels, where the receive and transmit frequencies are already the same.

In the 16-key and 4-key versions, when the “TA” function is activated, the “” icon will be indicated on the display.

Note that your dealer may have mode provision for “Talk Around” channels by programming “repeater” and “Talk Around” frequencies on two adjacent channels. If so, the key may be used for one of the other Pre-Programmed Functions.

ADVANCED OPERATION

TX SAVE DISABLE

Press the assigned programmable key, or set the **TOGGLE** switch to the assigned position to disable the Transmit Battery Saver, if you are operating in a location where high power is almost always needed.

The Transmit Battery Saver helps extend battery life by reducing transmit power when a very strong signal from an apparently nearby station is being received. Under some circumstances, though, your hand-held radio may not be heard well at the other end of the communication path, and high power may be necessary at all times.

ENCRYPTION (REQUIRES THE FVP-35 OR FVP-36)

Press the assigned programmable key to toggle the Encryption feature “On” and “Off”.

LOCK

Press the assigned programmable key, or set the **TOGGLE** switch to the assigned position to lock the **VX-920E**'s knob, programmable keys, and **PTT** switch. The precise lockout configuration is programmed by your Dealer.

Press the key again, or set the **TOGGLE** switch to a different position to disable the Lock function.

FOLLOW-ME SCAN

The “Follow-Me” Scan feature checks a User-assigned Priority Channel regularly as you scan other channels. Thus, if only Channels 1, 3, and 5 (of the 8 available channels) are designated for “Scanning”, the user may nonetheless assign Channel 2 as the “User-assigned” Priority Channel via the “Follow-Me” feature.

To activate “Follow-Me” scanning, first select the channel you want to designate as the “User-Assigned Priority Channel” and press the assigned programmable key, or set the **TOGGLE** switch to the assigned position. Then rotate the **CH** Selector knob to recall to the “Scanning Start” channel which has been programmed by your dealer to activate the scanner. When the scanner stops on an “Active” channel, the User-assigned Priority Channel will automatically be checked every few seconds; if activity is found on the User-assigned Priority Channel, the radio will switch between it and the Dealer-Assigned Priority Channel, if any.

ADVANCED OPERATION

AUDIO PC (PIC)

Press the assigned programmable key, or set the **TOGGLE** switch to the assigned position to toggle the Audio Pitch Controller “On” and “Off”. When you turn the Audio Pitch Controller “On”, the receive audio is enhanced in the high-range frequencies.

CLEAR VOICE

Set the **TOGGLE** switch to the assigned position to activates the Clear Voice feature. When you are operation in a noisy environment, activates the Clear Voice feature. Set the toggle switch to a different position to disable the Clear Voice feature.

GROUP RECALL SHORTCUT

Set the **TOGGLE** switch to the assigned position to recall the designated group.

FOLLOW-ME DUAL WATCH

To set up a “Dual Watch” frequency pair using the “Follow-Me” feature, select a channel using the **CH** Selector knob. Now press the assigned programmable key; pressing the assigned programmable key locks the current channel as the User-assigned Priority Channel. Now rotate the **CH** Selector knob to select another channel (not the “Scanning Start” channel). Your radio will now switch back-and-forth between the currently-selected channel and the User-assigned Priority Channel.

During “Follow-Me” scanning (after you have pressed the key), you can set up the “Dual Watch” feature by rotating the **CH** Selector knob to another channel. The radio will then scan back and forth between the original User-assigned Priority Channel and the newly-selected channel.

The Priority Channel you have assigned (before pressing the key) will be retained in memory until you change it.

ADVANCED OPERATION

GROUP UP/DOWN (16-KEY & 4-KEY VERSION ONLY)

Press the assigned programmable key to select a different group of channels. Once the desired Group is reached, rotate the **CH** Selector knob to select the desired channel within the selected Group.

You may wish to have the Scanner pass through more than one Group during the scanning process (normally, scanning is performed within the current group only). To include the current Group in the scanning loop, press and hold in the assigned programmable key for one second. To remove a Group from Group Scan, press and hold in the assigned programmable key again for one second.

Multi-Group Scanning is only possible if you are using the “User Scan” list. To edit the User Scan list, press and hold the assigned programmable key for one second to delete the current Memory Group from the Scanning. Alternatively, press and hold the assigned programmable key for one second to delete the Current Memory channel from the Scanning. When you delete a Group or channel, “**-SCAN Skip-**” will appear on the LCD for one second after pressing the assigned programmable key. To restore a particular channel to your scanning list, press and hold in the assigned programmable key again for one second;

“**-SCAN Stop-**” will appear on the LCD for one second after pressing the assigned programmable key.

CHANNEL UP/DOWN (16-KEY & 4-KEY VERSION ONLY)

Press the assigned programmable key to select a different channel within the current group.

SET (16-KEY & 4-KEY VERSION ONLY)

Press the assigned programmable key to activate the “User Set” (Menu) Mode. See page 28 for details

CALL/RESET

While the DTMF Paging System

This feature, if enabled, allows the user to change the 3-digit Page Call code, used to call other similarly-equipped stations. Press the assigned programmable key, followed by the three digits representing the Page Call code of the station you wish to call. Three tones will be heard after the last key is pressed (the new code will now be transmitted). The receiver squelch of the other station will be opened, and you can begin communication.

While the 2-Tone/5-Tone Paging System

This feature, if enabled, press the assigned programmable key to send a 2-tone/5-tone sequential tone.

ADVANCED OPERATION

CALL 1 TO CALL 5

Press the assigned programmable key to send a 2-tone/5-tone sequential tone group which is pre-defined.

CODE UP/DOWN (16-KEY & 4-KEY VERSION ONLY)

Press the assigned programmable key to select a 2-tone/5-tone encode code from the pre-defined encode list.

CODE SET (16-KEY & 4-KEY VERSION ONLY)

Press the assigned programmable key to change the encode digits for 5-tone operation. To change a specific digit, select the desired digit using the [A] key, then change the number using the [B]/[C] keys, and store the number using the [D] key.

SPEED DIAL (16-KEY VERSION ONLY)

Your Dealer may have pre-programmed Auto-Dial telephone number memories into your radio.

To dial a number, press the assigned programmable key, then press the front panel's numeric key corresponding to the Auto-Dial memory number list provided by your Dealer or Network Administrator. The DTMF tones sent during the dialing sequence will be heard in the speaker.

OPTION SW1

Press the assigned programmable key to toggle the optional accessory "1" "On" and "Off".

OPTION SW2

Press the assigned programmable key to toggle the optional accessory "2" "On" and "Off".

EMERGENCY

The **VX-920E** series include an "Emergency" feature which may be useful for alerting another party monitoring on the same frequency as your transceiver's channel.

Press the assigned programmable key to initiate an emergency call. For further details contact your Dealer.

HOME (16-KEY & 4-KEY VERSION ONLY)

Press the assigned programmable key to recall the pre-defined Home group/channel. When you recall the Home group/channel, the "- H -" notation will appear on the LCD.

SELECTABLE TONE (16-KEY & 4-KEY VERSION ONLY)

Press the assigned programmable key to select a sub-audible tone (CTCSS/DCS) from the pre-defined tone table. You can operate using the indicated sub-audible tone in the Selectable Tone mode.

ADVANCED OPERATION

DIRECT CH#1 - #4 (16-KEY & 4-KEY VERSION ONLY)

Press the assigned programmable key to recall the Dealer pre-programmed channel directly.

REC/PLAY (VOICE STORAGE: REQUIRES THE DVS-5)

This function allows your radio to record a received voice message, and to play back the recorded audio. It requires installation of the optional Voice Recording Unit.

Recording;

Press the assigned programmable key for 1.5 seconds to enable the Voice Recording Mode. If the incoming signal is received, so as to un-mute the squelch and pass audio, the received audio will be recorded.

In the 16-key and 4-key versions, the “

Playback;

Press the assigned programmable key momentarily to play back the last message.

To stop the play-back, press the **TOP SEL** key.

In the 16-key and 4-key versions, while playback is proceeding, you may press the **[A]** key (4-key version) or **[*]** key (16-key version) to jump to the previous message, or press the **[B]** key (4-key version) or

[#] key (16-key version) to jump to the next message. Furthermore, press the **[D]** key to clear the all messages and stop the play-back.

SQL (16-KEY & 4-KEY VERSION ONLY)

You can manually adjust the squelch level using this function:

- Press the assigned programmable key. A tone will sound, and the current squelch level will appear on the display.
- Press the **MONITOR/LAMP** button to select the desired squelch level.
- Two seconds after releasing the **MONITOR/LAMP** button, the display will revert to the normal channel indication.

AF MIN VR

Press the assigned programmable key to reduce the audio output to the (lower) level programmed by your Dealer.

STATUS SET (16-KEY & 4-KEY VERSION ONLY)

Press the assigned programmable key to change the 5-Tone status code. To change the status code, select the desired digit by **[A]** key, then change the number by **[B]/[C]** key, and store the number by **[D]** key.

ADVANCED OPERATION

STATUS UP/DOWN (16-KEY & 4-KEY VERSION ONLY)

Press the assigned programmable key to select a 5-Tone status code from the pre-defined status list.

STATUS CHECK (16-KEY & 4-KEY VERSION ONLY)

Press the assigned programmable key to check the 5-Tone receive status code. When you press this key, the LCD display will indicate the “Message” corresponding to the receive status condition per the pre-defined status list.

LONE WORKER

Press the assigned programmable key to toggle the Lone Worker feature “On” and “Off”. The Lone Worker feature is designed to emit an alarm for 30 seconds when the Lone Worker Timer (programmed by your Dealer) has expired. If the user does not reset the timer by pressing the **PTT** switch, the radio switches to the Emergency mode.



DTMF CODE SET (16-KEY VERSION ONLY)

You may send the desired telephone number manually.

To dial a number manually, press the assigned programmable key, then press the desired numbers on the front panel’s numeric key. Now, press the **PTT** switch to send the telephone number. The DTMF tones sent during the dialing sequence will be heard in the speaker.

TA SCAN

Press the assigned programmable key to toggle the TA (Talk Around) scan feature “On” and “Off”.

While TA scan is proceeding, the **VX-920E** will search both the transmit and receive frequencies (In the 16-key and 4-key versions, the “” icon will blink). When a signal is encountered on the receive frequency, the **VX-920E** will pause until the signal disappears (“” icon will appear but not blink). When a signal is encountered on the transmit frequency, the **VX-920E** will check for activity on the receive frequency every few seconds (interval programmed by your Dealer).

ARTS™ (AUTO RANGE TRANSPOND SYSTEM)

This system is designed to inform you when you and another ARTS™-equipped station are within communication range.

During ARTS™ operation, when the radio receives the correct ARTS™ signal, a short beep will sound and the “**IS**” (meaning “In Service”) notation will be displayed on the sub-LCD*. If you move out of range for more than two minutes, your radio senses that no signal has been received; three short beeps will sound, and “**OOS**” (“Out of Service”) will be displayed on the sub-LCD*. If you subsequently move back into range, as soon as the other station transmits, a short beep will sound and “**IS**” will be displayed again on the sub-LCD*.

※: Except on Non-LCD version.

DTMF PAGING SYSTEM

This system allows paging and selective calling, using DTMF tone sequences.

When your radio is paged by a station bearing a tone sequence which matches yours, your radio's squelch will open and the alert will sound. The three-digit code of the station which paged you will be displayed on your radio's LCD.

LOCK

In order to prevent accidental channel change or inadvertent transmission, various aspects of the **VX-920E**'s knob, programmable keys, and **PTT** switch may be locked.

The precise lockout configuration is programmed by your Dealer.

To locked out the key locking, turn the radio off. Now, press and hold the **PTT** and **SIDE SEL** key while turning the radio on again.

To cancel locking, repeat this process.

USER SET MODE

The 16-key and 4-key versions of the **VX-920E** include a “User Set (Menu)” Mode which allows the user to define or configure various settings, such as Beep On/Off, Squelch Threshold Level, LCD Contrast, etc.

To activate the “User Set (Menu)” Mode:

- Press the assigned programmable key for the “SET” function to enter the “User Set Mode”.
- Select the User Set Mode Item you want change using the **CH** selector knob.
- Press the **MONITOR/LAMP** button to select the status of the selected item.
- Rotate the **CH** selector knob one click to save the new setting.
- Press **PTT** switch to exit to normal operation.

DISPLAY	DESCRIPTION
1 SQL	Select the Squelch Threshold Level.
2 SCN List	Select the Scan List “User” or “Dealer”.
3 BEEP	Set the Beep On/Off.
4 BELL	Set the Bell On/Off. (Bell engaged by Sub-audible CTCSS/DCS)
5 Lighting	Set the BUSY/TX LED On/Off.
6 Lock	Set the Lock function to be Locked. (Key/PTT/Key+PTT)
7 Group	Set the Operation Group.
8 SCAN	Set the Scan status. (Same function as Scan key)
9 DW	Set the Dual Watch status. (Same function as DW key)
10 TA	Set the Talk Around status. (Same function as TA key)
11 AF Min VR	Set the Minimum Volume level.
12 Beep VR	Set the Beep Volume level.
13 Contrast	Set the LCD Contrast.
14 Pitch	Select the Special Receiver Audio Response.
15 REC Mode	ONE: Enables recording one message (Max. 120 seconds), and playback from the beginning of the message. ROL: Enables recording whenever squelch opens, and playback of the last 120 seconds.
16 Play Mode	Set the priority audio on playback mode. PLY: Playback audio is higher priority than received signal. SIG: Received signal is higher priority than playback audio.

Note: The menu “15: REC Mode” and “16: Play Mode” will appear only when the optional **DVS-5** Digital Voice Storage Unit is installed.

OPTIONAL ACCESSORIES

FNB-V127LI-UNI	7.4V, 1380 mAh Li-Ion Battery Pack	FVP-35	Rolling Code Encryption Unit
FNB-V128LI-UNI	7.4V, 2300 mAh Li-Ion Battery Pack	FVP-36	Inversion Encryption Unit
FNB-V129LI-UNI	7.4V, 3000 mAh Li-Ion Battery Pack	DVS-5	Digital Voice Storage Unit
FNB-V86LIA	7.4V, 1380 mAh Li-Ion Battery Pack	VME-100	MDC1200®/GE-STAR® ANI Encoder Unit
FNB-V87LIA	7.4V, 2300 mAh Li-Ion Battery Pack	VMDE-200	MDC1200®/GE-STAR® ANI Enc/Dec Unit
FNB-V92LI	7.4V, 3000 mAh Li-Ion Battery Pack	ATV-2A	VHF Antenna (66-71 MHz)
FBA-34	Alkaline Battery Case (6 x AA)	ATV-2B	VHF Antenna (70-76 MHz)
CD-58	Desktop Rapid Charger (for FNB-V12xLI-UNI Battery)	ATV-2C	VHF Antenna (75-81 MHz)
PA-55	AC Adapter (for CD-58)	ATV-2D	VHF Antenna (81-88 MHz)
VAC-UNI	Desktop Rapid Charger (CD-58+PA-55) (for FNB-V12xLI-UNI Battery)	ATV-8A	VHF Antenna (134-151 MHz)
CD-31	Desktop Rapid Charger (for FNB-V86LIA/-V87LIA/-V92LI)	ATV-8B	VHF Antenna (150-163 MHz)
PA-42	AC Adapter (for CD-31)	ATV-8C	VHF Antenna (161-174 MHz)
VAC-920	Desktop Rapid Charger (CD-31+PA-42) (for FNB-V86LIA/-V87LIA/-V92LI)	ATU-6A1	UHF Antenna (400-430 MHz)
VAC-6058	6-Unit Multi Charger (for FNB-V12xLI-UNI Battery)	ATU-6C	UHF Antenna (440-470 MHz)
VAC-6920	6-Unit Multi Charger (for FNB-V86LIA/-V87LIA/-V92LI)	ATU-6D	UHF Antenna (450-490 MHz)
MH-66A7A	Submersible Speaker/Microphone	ATU-6F	UHF Antenna (490-512 MHz)
MH-66B7A	Submersible Speaker/Microphone (with Speaker-Volume Toggle Switch & Programmable Key)	LCC-920	Leather Case
DCM-1	Desktop Charger Mounting Adapter (for CD-31)	CLIP-920	Belt Clip
VCM-2	Vehicular Charger Mounting Adapter (for CD-31)	CE59	Programming Software
		FIF-12	USB Programming Interface
		CT-108	PC Programming Cable (for FIF-12)
		FRB-6	Tuning Interface Box
		CT-161	Connection Cable (for FRB-6)
		CT-116	Radio to Radio Cloning Cable

Availability of accessories may vary; some accessories are standard per local requirements, others may be unavailable in some regions. Check with your Vertex Standard Dealer for changes to this list.

DISPOSAL OF YOUR ELECTRONIC AND ELECTRIC EQUIPMENT

Products with the symbol (crossed-out wheeled bin) cannot be disposed as household waste.

Electronic and Electric Equipment should be recycled at a facility capable of handling these items and their waste by products.

In EU countries, please contact your local equipment supplier representative or service center for information about the waste collection system in your country.



ATTENTION IN CASE OF USE

This transceiver works on frequencies which are not generally permitted.

For frequency allocation, apply for a licence at your local spectrum management authority.

For actual usage contact your dealer or sales shop in order to get your transceiver adjusted to the allocated frequency range.

List of the practicable area

AUT	BEL	CYP	CZE	DEU	DNK	ESP	EST	FIN
FRA	GBR	GRC	HUN	IRL	ITA	LTU	LUX	LVL
MLT	NLD	POL	PRT	SVK	SVN	SWE	CHE	ISL
LIE	NOR							



Copyright 2014
Vertex Standard LMR, Inc.
All rights reserved.

No portion of this manual
may be reproduced
without the permission of
Vertex Standard LMR, Inc.

Printed in China

